

A NUMERICAL ANALYSIS OF THE RESISTANCE AND STIFFNESS OF THE ALUMINIUM AND CONCRETE COMPOSITE BEAM

Łukasz POLUS¹, Maciej SZUMIGAŁA

Poznan University of Technology, Institute of Structural Engineering, Poland

Abstract

In this paper a numerical analysis of the resistance and stiffness of the aluminium and concrete composite beam is presented. Composite aluminium and concrete structures are quite new and they have not been thoroughly tested. Composite structures have a lot of advantages. The composite aluminium and concrete beam is more corrosion-resistant, fire-resistant and stiff than the aluminium beam. The contemporary idea of sustainable buildings relies on new solutions which are more environmentally friendly. Aluminium is lighter and more resistant to corrosion than steel, which is often used in composite structures.

Keywords: composite aluminium and concrete beam, numerical analysis

1. INTRODUCTION

Aluminium alloys are increasingly more often used as a construction material. The difference in price between aluminium alloys and steel alloys is decreasing. When looking for new solutions, designers should focus on their resistance and on reducing the consumption of natural resources. Aluminium alloys are fully recyclable [2]. What is more, they are corrosion-resistant thanks to aluminium oxide. A 0.001 μ m-thick layer of aluminium oxide forms on the clean and fresh surface of aluminium within a few seconds. In normal conditions, the thickness

¹ Corresponding author: Poznan University of Technology, Institute of Structural Engineering, Faculty of Civil and Environmental Engineering, Piotrowo st 5, 60-965 Poznan, Poland, e-mail: lukasz.polus@put.poznan.pl, tel. +48616652401

of aluminium oxide increases to 0.01 μm within a few days and to 0.1 μm within a few years [5].

The lightness of material is an important design parameter. According to [2], it is defined as:

$$\kappa = \frac{\rho}{f_k} \quad (1.1)$$

where:

ρ - volume weight [kN/m^3]

f_k - characteristic resistance [MPa]

When comparing the lightness of basic construction materials, such as steel, concrete, wood and aluminium, aluminium alloys prove to be the lightest. Concrete is the heaviest material, followed by steel and wood.

Mromliński [5] has already addressed the issue of composite aluminium and concrete structures. He described a composite girder consisting of an aluminium beam and a reinforced concrete slab. The cooperation of both elements of the girder is better than in a similar girder with a steel beam. Mromliński [5] analysed the influence of Young's modulus on the stresses of the bottom edge of the composite aluminium beam.

$$n = \frac{E_a}{E_c} \quad (1.2)$$

where:

E_a - modulus of elasticity of structural aluminium

E_c - modulus of elasticity of concrete

The stresses of the bottom edge of the composite girder were lower when the steel beam was replaced with the aluminium beam [5].

The most important problem in the composite aluminium and concrete beam is how to develop a connector which would join both materials. The welding of shear connectors to aluminium beams reduces the strength properties around the welds [7]. The authors of the article are trying to patent a new type of steel shear connector, which may be used without welding. The connector is presented in Fig. 1.

Spacers were used to prevent corrosion, which may occur at the point of contact of the profiled steel sheeting and the aluminium beam.

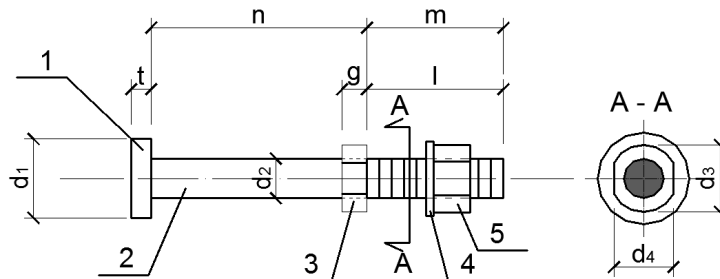

Fig. 1. Shear connector: 1 - head, 2 - shank, 3 - flange, 4 - washer, 5 - nut

The next problem is that there are no standards for designing composite aluminium and concrete beams. The existing standard [6] for designing composite structures applies to steel and concrete structures only. However, it may be used to estimate the resistance of the composite aluminium and concrete beam. When the plastic resistance is known and $A_a f_{yd} < 0,85 f_{cd} b_{eff} h_c$, the location of the neutral axis relative to the upper surface of the concrete slab may be determined with the use of the following formula:

$$0,85 f_{cd} b_{eff} x_{pl} = f_{yd} A_a \quad (1.3)$$

where:

f_{cd} - design value of the cylinder compressive strength of concrete

b_{eff} - total effective width of the concrete slab

x_{pl} - distance between the plastic neutral axis and the extreme fibre of the concrete slab in compression

f_{yd} - design value of the yield strength of structural aluminium

A_a - cross-sectional area of the structural aluminium section

According to [4], the plastic resistance moment $M_{pl,Rd}$ of a composite cross-section may be determined using the following equation:

$$M_{pl,Rd} = f_{yd} A_a (d_c - 0,5 x_{pl}) \quad (1.4)$$

where:

d_c - distance between the centre of gravity of the aluminium section and the edge of the concrete slab

2. THE PLASTIC RESISTANCE MOMENT OF THE COMPOSITE ALUMINIUM AND CONCRETE BEAM ACCORDING TO EN 1994-1-1

The plastic resistance moment $M_{pl,Rd}$ of the composite cross-section was determined using [6] and the guidelines set out in [4] and [1]. The data used for calculation are presented in Table 1.

Table 1. Data

Data	Symbol	Value	Unit
Beam span	L	5.20	m
Beam scheme	Simply supported		
Height of the concrete slab	h	150.0	mm
Width of the concrete slab	b	656.0	mm
Thickness of the concrete above the steel sheeting	h_c	95.0	mm
Aluminium alloy	EN AW-6063 EN AW-AlMg0,75Si T6 HB=74		
Value of the yield strength of structural aluminium	f_o	170	MPa
Tensile strength of structural aluminium	f_u	215	MPa
Aluminium section	I-section 300		
Height of the aluminium section	h_a	300	mm
Width of the shelf of the aluminium section	b_f	170	mm
Thickness of the shelf of the aluminium section	t_f	15	mm
Thickness of the web of the aluminium section	t_w	8	mm
Class of the aluminium section according to [7]	3		
Concrete	C35/45		
Diameter of the shear connector	d	19	mm
Material of the shear connector	S235		
Steel sheeting	T55P		
Material of the steel sheeting	S235		
Thickness of the steel sheeting	g	1.0	mm

The position of the neutral axis was determined on the basis of the equation (1.3) $x_{pl} = 95,0$ mm (directly above the steel sheeting). The composite aluminium and concrete beam is presented in Fig. 2. and 3.

The plastic resistance moment is 311.6 kNm according to equation (1.4). Such a plastic resistance may be difficult to achieve, because the cross-section of the aluminium beam is of Class 3 according to [7]. What is more, aluminium alloys have a characteristic value proof strength of 0.2 %. The resistance of the aluminium beam according to [7] is 127.5 kNm. The calculations are presented in Table 2.

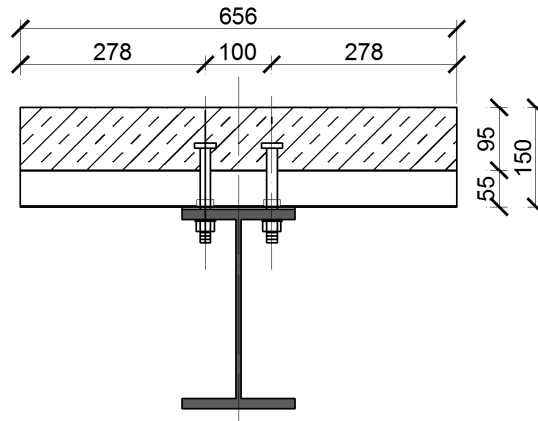

Fig. 2. A section of the composite aluminium and concrete beam

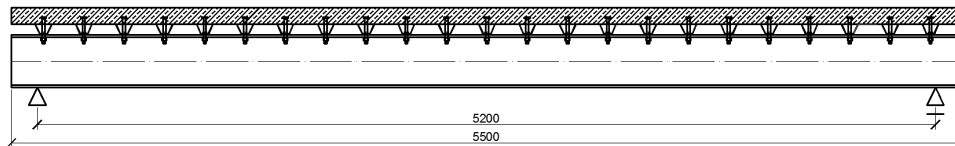

Fig. 3. A side view of the composite aluminium and concrete beam

Table 2. The calculation of the resistance of the aluminium beam according to PN-EN 1999-1-1

Parameter	Value
Material classification	Class A
Class of the web	3
Class of the shelf	2
The characteristic value of 0,2 % proof strength	$f_o=17.0\text{kN/cm}^2$
The shape factor	$\alpha=1.06$
The partial factor for resistance of cross-section	$\gamma_{M1}=1.1$
The elastic modulus of the section	$W_{el}=778.53\text{cm}^3$
The design resistance for bending	$M_{o,Rd}=127.5\text{kNm}$

The plastic resistance moment of the composite aluminium and concrete beam is 2.4 times greater than that of the aluminium beam alone. However, the plastic resistance moment of the composite aluminium and concrete beam should be verified using laboratory tests and numerical analysis.

3. A NUMERICAL ANALYSIS OF THE COMPOSITE ALUMINIUM AND CONCRETE BEAM

In order to check the resistance of the composite aluminium and concrete beam, a numerical analysis of the composite structure was prepared in the Abaqus program. A model of the beam is presented in Fig. 4.

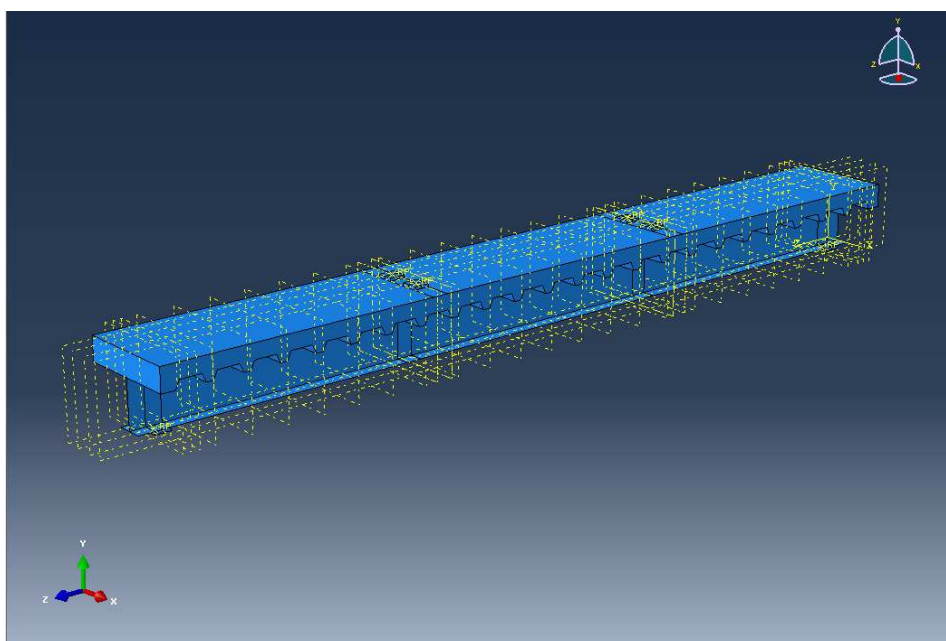

Fig. 4. A model of the composite aluminium and concrete beam

The model consists of an aluminium beam and a concrete slab on profiled steel sheeting. The slab and the beam were joined with the shear connectors which were embedded in the slab. The geometry of the model was replaced by finite elements. The model of the concrete slab was created with eight-node cuboidal finite solid elements and the model of the aluminium beam was created with four-node shell elements. The model of the shear connectors was created with beams. In Fig. 5 the steel sheeting is presented as the skin of the concrete slab.

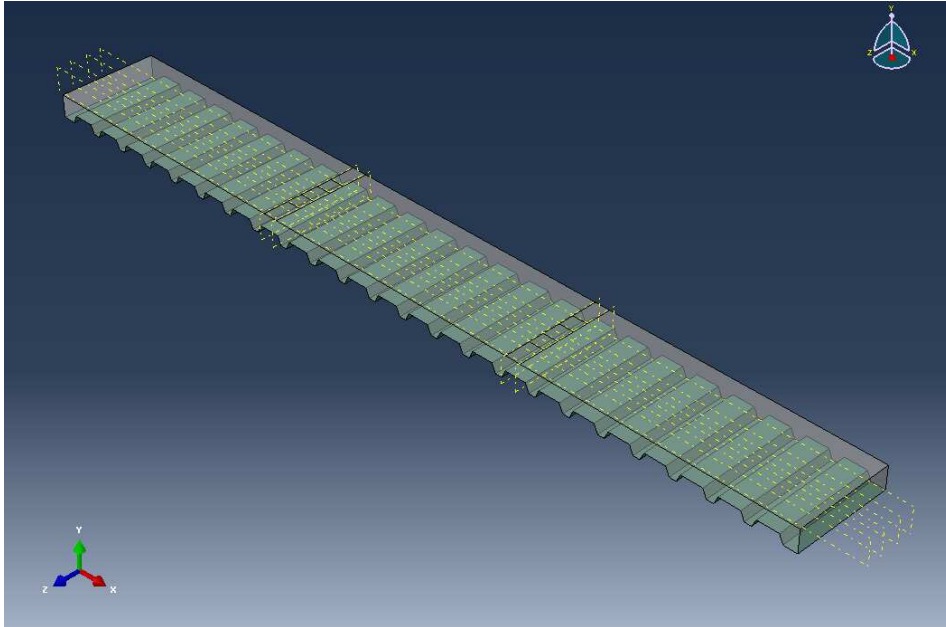

Fig. 5. The steel sheeting as the skin of the concrete slab

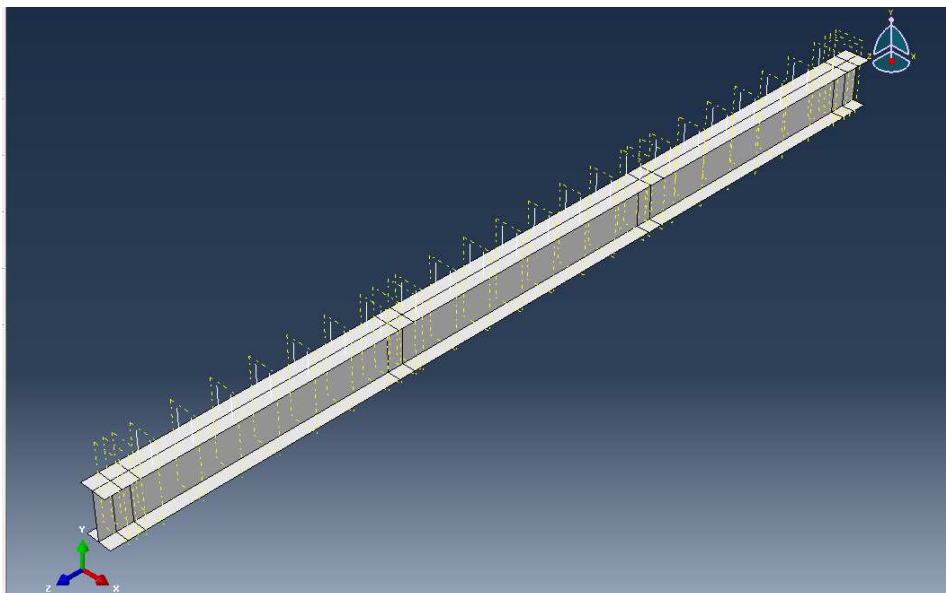

Fig. 6. The shear connectors and the aluminium beam

The laws of physics for each material are shown in the figures below.

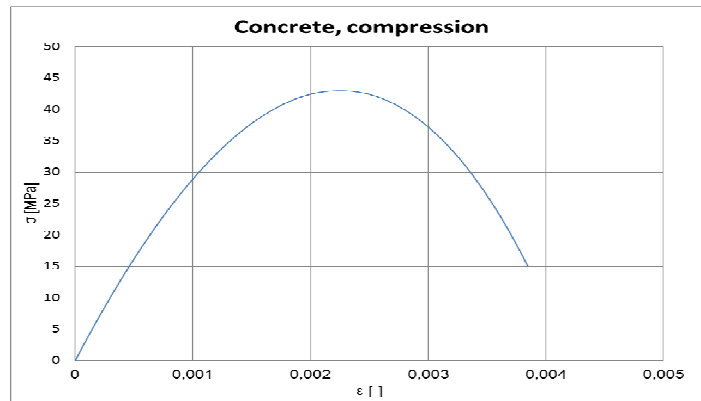

Fig 7. Stress-strain relations for concrete, compression [8] and [3]

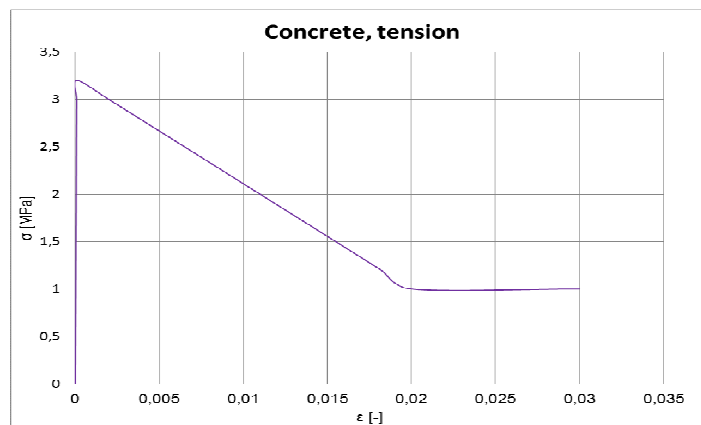

Fig 8. Stress-strain relations for concrete, tension [8]

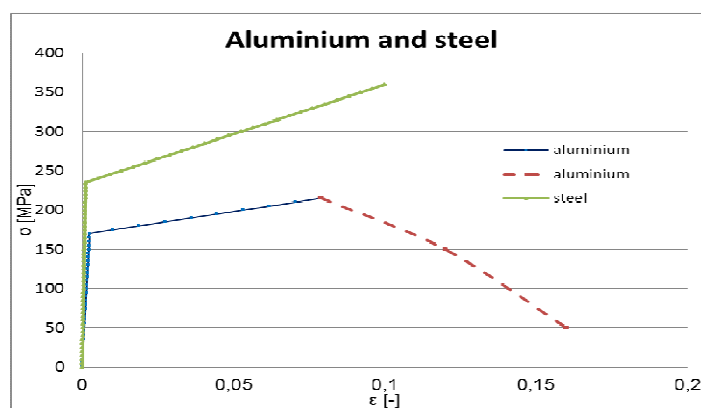

Fig. 9. Stress-strain relations for steel and aluminium

The calculations were performed using the Abaqus-Standard procedure and the Newton-Raphson method. Load was applied in the form of displacement. It was assumed that the resistance of the shear connectors is reached when there is a local extreme on the static equilibrium path. The points where displacements were applied are shown in Figure 10.

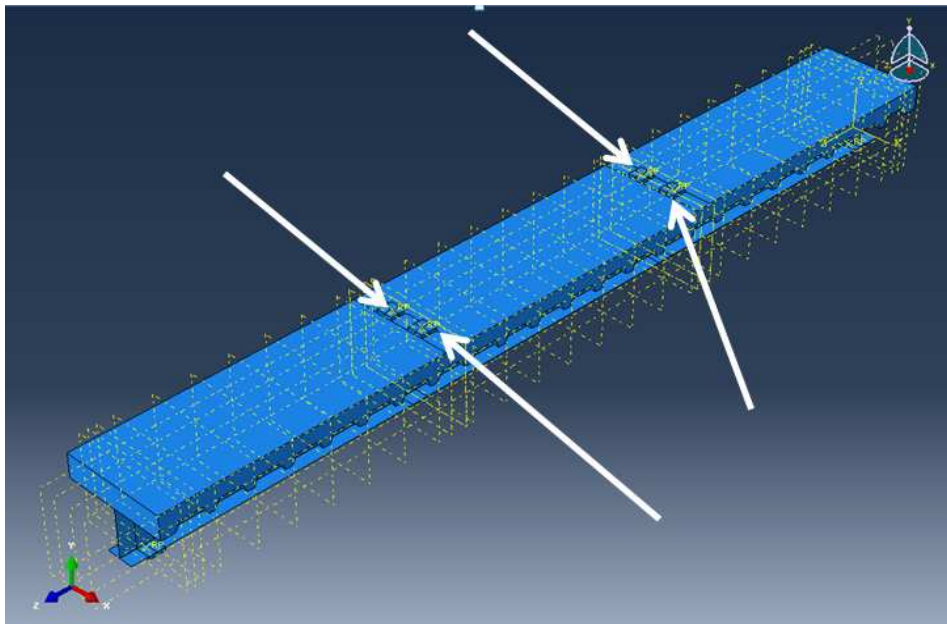

Fig. 10. The points where displacements were applied

As a result of the analysis, a strain energy curve was obtained, which had a local extreme. The strain energy curve is presented in Fig. 11.

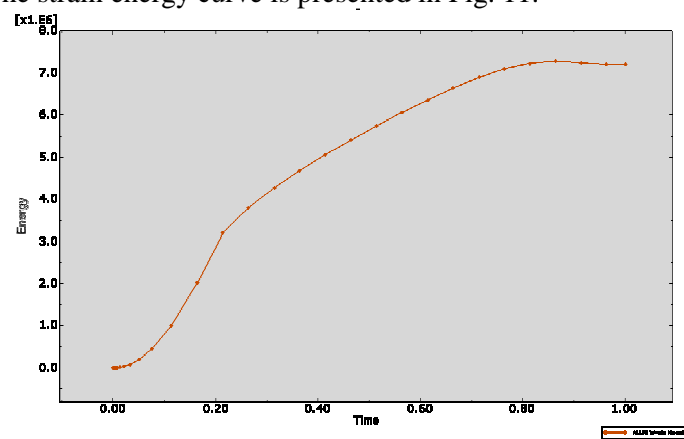

Fig. 11. The strain energy curve

The curve of the force at one of the points where the displacements were applied is presented in Fig. 12.

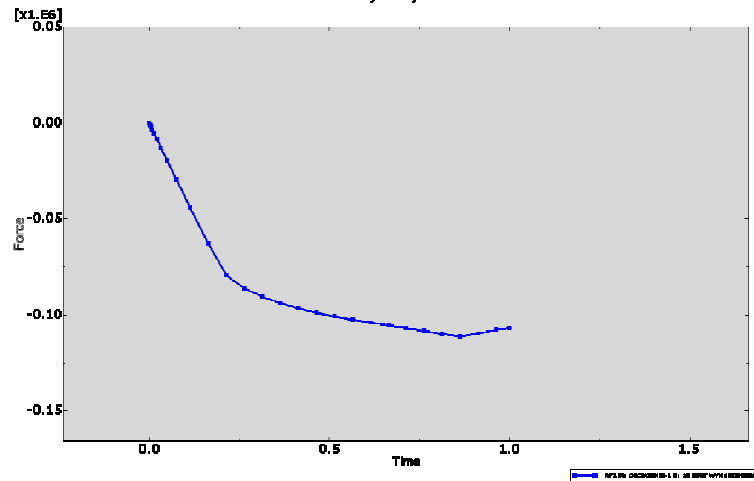

Fig. 12. The curve of the force at one of the points

The maximum force is 111.0 kN. The resistance of the composite aluminium and concrete beam is 375.2 kNm. The stresses for the maximum load are presented in Fig. 13 and 14.

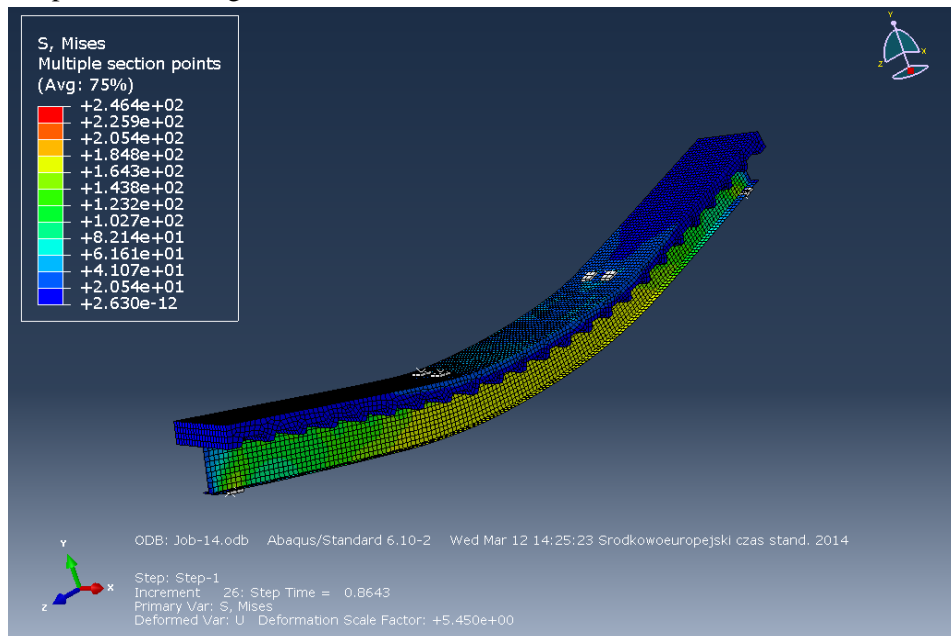

Fig. 13. A map of the equivalent Huber-Mises-Hencky's stresses

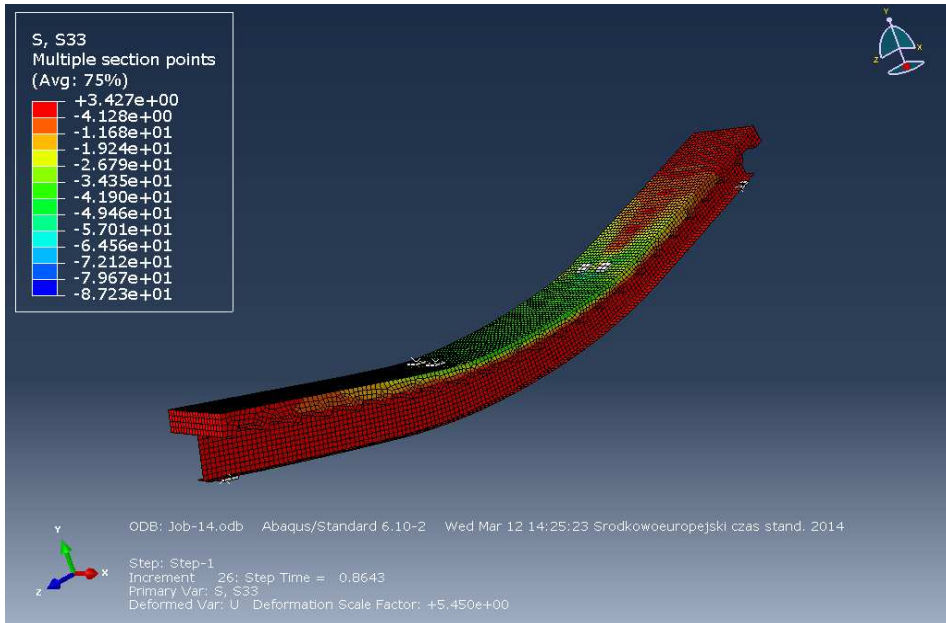

Fig. 14. A map of the main stresses S33

The stresses of the shear connectors are presented in Fig. 15. Some of the shear connectors plasticized.

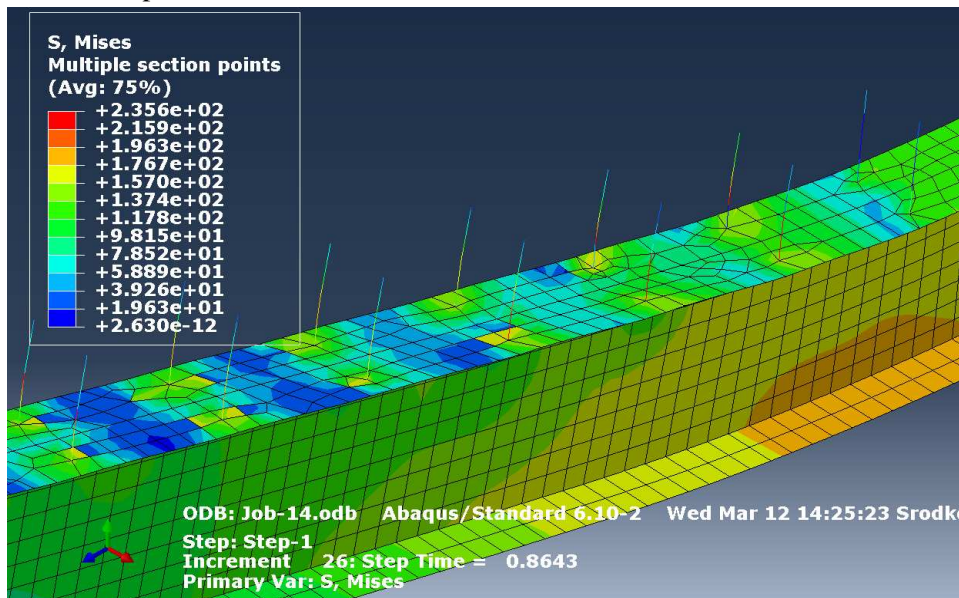

Fig. 15. The stresses of the shear connectors

The displacement of the concrete slab relative to the aluminium beam is shown in Fig.16 and it amounts to 1.22 mm.

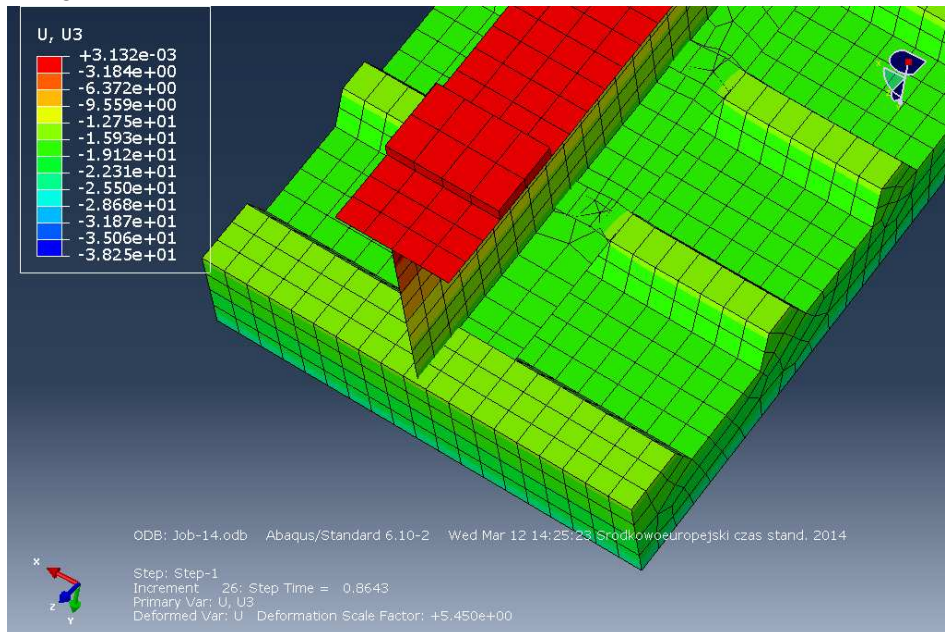

Fig. 16. The displacement of the concrete slab relative to the aluminium beam

The deflection which was accompanying the maximum force is presented in Fig. 17.

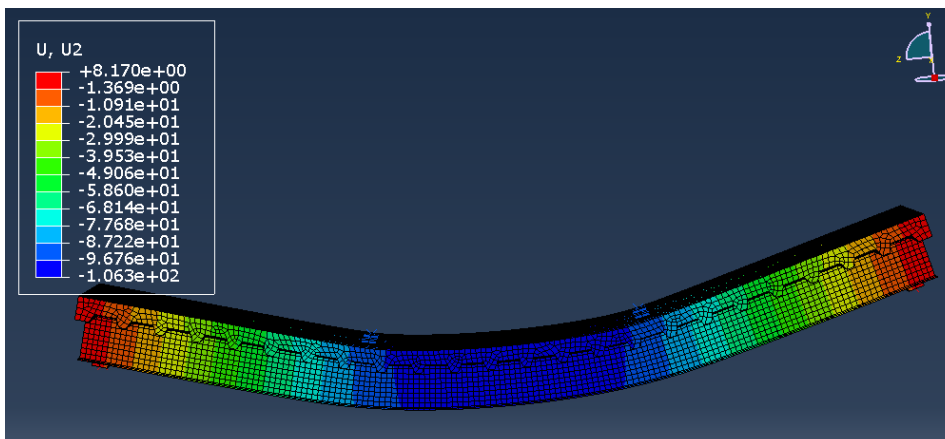

Fig. 17. The deflection of the composite aluminium and concrete beam

The maximum deflection is 10.6cm. The large span of the beam (5.2m) and small modulus of elasticity for aluminium ($70\,000\text{ N/mm}^2$) are the causes of the large deflection.

4. CONCLUSION

Composite aluminium and concrete structures still require a lot of tests. They are a new alternative to composite steel and concrete structures, which better fulfils the requirements of sustainable building. By combining the aluminium beam with the concrete slab, resistance and stiffness are increased. Table 3. presents the resistance of the aluminium beam, the resistance of the composite aluminium and concrete beam calculated according to EN 1994-1-1 and the resistance of the composite aluminium and concrete beam obtained from the numerical analysis.

Table 3. Bending load capacity

Bending load capacity		
Aluminium beam	Composite aluminium and concrete beam according to EN 1994-1-1	Composite aluminium and concrete beam from the numerical analysis
127.5 kNm	311.6 kNm	375.2 kNm

The analysis presented in the article shows that the cooperation between the aluminium beam and the concrete slab is possible.

The stiffness of the aluminium and concrete beam is small, because of the large span of the beam (5.2m) and the small modulus of elasticity for aluminium ($70\,000\text{ N/mm}^2$).

The numerical model should be validated once laboratory tests of the beams have been carried out. Moreover, the laboratory tests of the innovative shear connectors and the composite aluminium and concrete beam make it possible to create a more accurate model of shear connectors in the Abaqus program.

ADDITIONAL INFORMATION

Financial support by the 01/11/DSMK/0292 is kindly acknowledged. The authors of the article wish to thank RYWAL-RHC for the shear connectors used for the tests.

REFERENCES

1. Giżejowski M.: *Budownictwo ogólne, Tom 5, Stalowe konstrukcje budynków, projektowanie według eurokodów z przykładami obliczeń*, Arkady, Warszawa 2010.

2. Gwóźdź M.: *Problemy projektowe współczesnych konstrukcji aluminiowych*, Czasopismo Techniczne, Wydawnictwo Politechniki Krakowskiej, Kraków 2007.
3. Kmiecik P., Kamiński M.: *Modelling of reinforced concrete structures and composite structures with concrete strength degradation taken into consideration*, Archives of Civil and Mechanical Engineering, Vol. XI, No. 3, 2011.
4. Kucharczuk W., Labocha S.: *Konstrukcje zespolone stalowo-betonowe budynków*, Arkady, Warszawa 2007.
5. Mromliński R.: *Konstrukcje aluminiowe*, Arkady, Warszawa 1975.
6. PN-EN 1994-1-1, Eurokod 4, *Projektowanie zespolonych konstrukcji stalowo-betonowych Część 1-1: Reguły ogólne i reguły dla budynków*, Polski Komitet Normalizacyjny 2008.
7. PN-EN 1999-1-1, Eurokod 9, *Projektowanie konstrukcji aluminiowych, Część 1-1: Reguły ogólne*, Polski Komitet Normalizacyjny 2011.
8. PN-EN 1992-1-1, Eurokod 2, *Projektowanie konstrukcji z betonu, Część 1-1: Reguły ogólne i reguły dla budynków*, Polski Komitet Normalizacyjny 2008.

ANALIZA NUMERYCZNA NOŚNOŚCI I SZTYWNOŚCI BELKI ZESPOLONEJ ALUMINIOWO - BETONOWEJ

Streszczenie

W artykule przedstawiono wyniki analizy numerycznej nośności i sztywności belki zespolonej aluminiowo-betonowej. Konstrukcje aluminiowo-betonowe są stosunkowo nowymi konstrukcjami zespolonymi i nie są jeszcze dostatecznie przebadane. Połączenie aluminium z betonem ma wiele zalet. Belki zespolone aluminiowo-betonowe mają większą nośność, sztywność oraz odporność ogniową niż aluminiowe belki. Współczesna idea budownictwa zrównoważonego wymaga od projektantów stosowania nowych rozwiązań, które będą bardziej przyjazne środowisku. Aluminium jest lżejsze od stali i ma większą odporność na korozję niż stal. Analiza przedstawiona w artykule wykazała, że możliwa jest współpraca belki aluminiowej i betonowej płyty. Analizowana belka aluminiowo-betonowa ma dużo większą nośność od belki aluminiowej.

Słowa kluczowe: belki zespolone betonowo-aluminiowe, analiza numeryczna

Editor received the manuscript: 7.07.2014