

VERTICAL EXTENSION OF A MULTI-STOREY REINFORCED CONCRETE BUILDING

A.BAHRAMI*, S.DENIZ and H.MOALIN

Department of Building Engineering, Energy Systems and Sustainability Science, Faculty of Engineering and Sustainable Development, University of Gävle, 801 76 Gävle, SWEDEN

E-mail: Alireza.Bahrami@hig.se

The global population is increasing annually; thus, there is a need for more housing and buildings worldwide. As cities grow outward and buildable lands become scarce, it is necessary to increase the height of existing buildings in cities, especially where the height of the buildings is low. For crowded cities, the storey extension is an increasingly popular measure that can meet market demand for centrally located houses. This paper examines the possibility of the vertical extension of an existing (reference) reinforced concrete building in Gävle in Sweden. The StruSoft FEM-Design program is employed to carry out the research. The building is firstly modelled, analysed and designed completely. Thereafter, a storey extension is conducted vertically. The stresses and utilisation ratios of the load-bearing elements of the reference and extended buildings are assessed. It is found that some of the load-bearing elements of the building after the extension need strengthening. Different practical strengthening solutions are proposed. It is concluded that the building can successfully withstand the vertical extension after applying these proposed solutions. The maximum vertical reaction forces of the reference and extended buildings are obtained and compared. A comparison of the deflections of the buildings is made. The structural stability of the buildings is evaluated as well.

Key words: vertical extension, reinforced concrete building, utilisation ratio, reaction force, deflection.

1. Introduction

The geographical scope of the metropolitan regions is expanding at the same time as societies have limited urban areas. Since the start of the industrialisation at the end of the 19th century, the development of the societies in most parts of the world has had a clear direction of urbanisation from rural to densely populated areas. When the population growth increases, there is an urban expansion, which also leads to more buildings being built to a greater extent in undeveloped spaces. A forecast from the Swedish statistical authority shows that the population of Sweden is estimated to increase by 1 million by 2034 [1], which is based on the number of persons who will be born and immigrate to Sweden. The growing global population demands have continued the demand and construction of more new houses for all residents.

As urbanisation continues, larger cities grow and new places are gradually connected in regions. With the help of new and developed public transport, towns can be connected very adaptably. It also means that the pressure in the cities is growing, which in turn places great emphasis on the smooth working of communications and connections.

The increased population requires more housing, which will be a continued challenge in the future. In cities where the pressure is already high, it can be difficult to build more new buildings as required unusable land spaces are insufficient. However, the increasing growth must take place in a strategic and structured way so that the nature and cultural environments are preserved. When wildlife is replaced with buildings in the cities, they affect the well-being of individuals since nature and greenery are important resources to meet the public health challenges.

* To whom correspondence should be addressed

As usable land spaces become an increasingly scarce commodity in larger cities, and thus the surface areas become more valuable, the necessary alternative measures should emerge. An alternative is the vertical extension of existing buildings which is a step towards sustainable development [2]. The storey extension does not require the use of new land or installations. When buildings are extended vertically in height, both valuable lands and green spaces are saved in big cities [3]; further, it can lead to an economic and environmental benefit, because in some cases, vertical additions can enable an energy-efficient renovation of the existing buildings. Renovations and conversions of the existing buildings can take place when a storey extension is to be carried out. The storey extension can therefore be a good alternative and possibility in which the existing buildings should be reviewed. When building an extension, it is extremely important to first and foremost get to know the existing building.

The extensions of buildings have been investigated in some studies [4-13], whilst, there is still a lack of knowledge and research in this area as well as issues that have not been addressed. Also, there are technical challenges that come with vertical additions which need more investigations [13]. Consequently, the current research deals with the vertical extension of an existing (reference) reinforced concrete (RC) building in Gävle in Sweden. The StruSoft FEM-Design (FEM) program is used herein. The reference and extended buildings are modelled, analysed and designed. The buildings are compared with regard to their stresses, utilisation ratios and deflections. The obtained maximum vertical reaction forces of the buildings are compared too. The structural stability of the buildings is checked.

2. Methodology

The methodology of this study includes modelling, analysis and design of a reference multi-storey RC building in Gävle in Sweden using the FEM. The building is modelled, analysed and designed utilising the available data and based on the Eurocodes [14-18] and also the Swedish national annex (EKS 10) [19]. It is studied how the building is affected if another storey is built on its top and whether this issue is possible with or without making changes in the building.

2.1. Specifications of reference building

A reference RC building was used as a starting point. This building is located in Gävle in Sweden with HSB as the property owner. It is in a fantastic location in the proximity to the train station and city centre. To live there, the applicants must be between 18-25 years old, as it is a youth residence. The building consists of a total of three storeys with a roof having 6-degree slope on all of its four sides. The roof design and the slope make it much easier to lift up the roof during an extension. The floor plan is 30.510 m long and 12.428 m wide. The features of the storeys of the building are summarised in Table 1. The building has load-bearing RC walls that support it and stabilise the structural frame. The building's floor plans are illustrated in Figs. 1 and 2 along with the plan of their load-bearing RC walls in Fig.3. The reference building was photographed by the authors of the paper, as demonstrated in Fig.4.

Table 1. Specifications of storeys of building.

Storey	Height (m)
Storey 1	2.6
Storey 2	2.6
Storey 3	2.5
Roof	1.7 (to ridge, roof angle 6°)

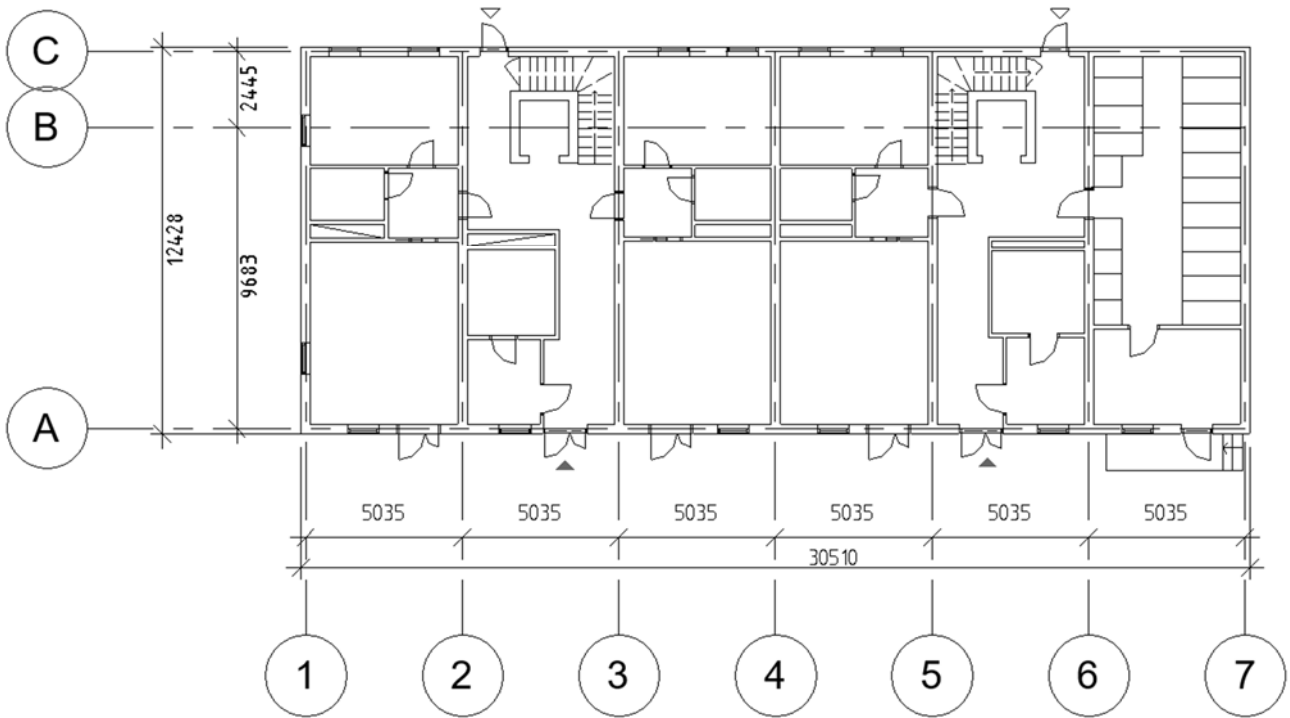

Fig.1. Plan of storey 1 (unit: mm).

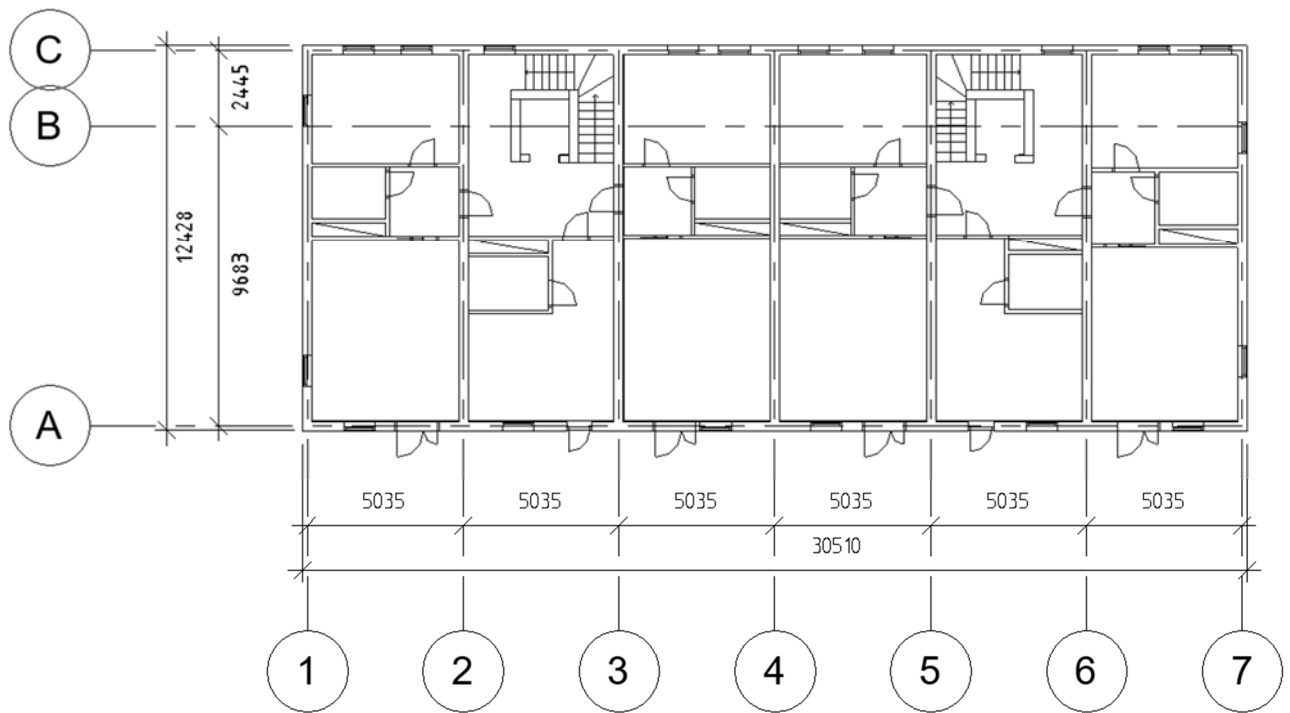

Fig.2. Plan of storeys 2 and 3 (unit: mm).

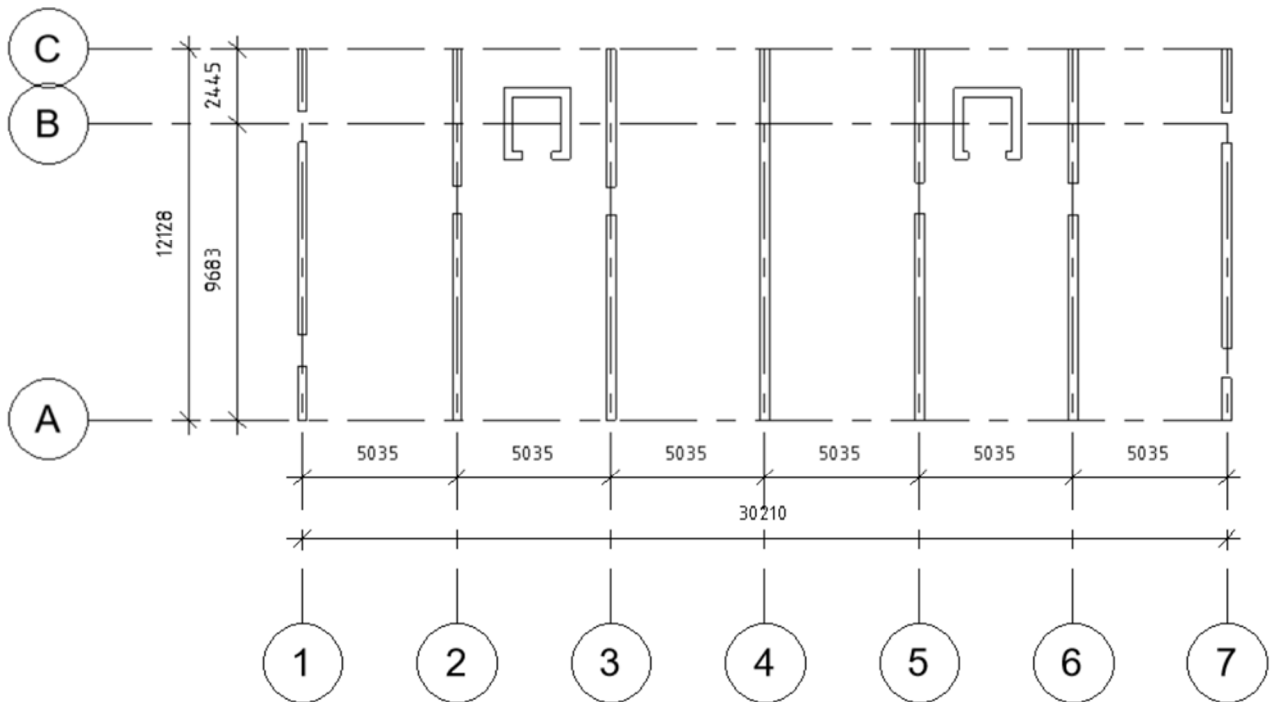

Fig.3. Plan of load-bearing RC walls (unit: *mm*).



Fig.4. Studied building.

2.2. Modelling reference building

The investigation was conducted with a precise modelling of the building's elements consisting of all the input data such as the floors plans, building's specifications, loads, strength classes and dimensions. The load-bearing walls and slabs were made of concrete with the strength class of C30/37. The thicknesses of the RC walls

and slabs were 150 mm and 180 mm , respectively. The fixed line support was considered for the load-bearing RC walls where the walls had their support against the ground. The main structural elements of the attic were composed of steel beams and columns made of KKR. The timber boards, L (T), were placed between the beams to cover the roof, which were supported by exterior timber walls on the short and long sides of the building. The elevator shafts and stairwells continued 0.3 m above the ridge, which means that it extended all the way up above the roof. The elevator shafts and stairwells had perimeter load-bearing RC walls as well. Figs. 5-8 display the facades of the modelled building. A three-dimensional (3D) view of the modelled building is shown in Fig.9.

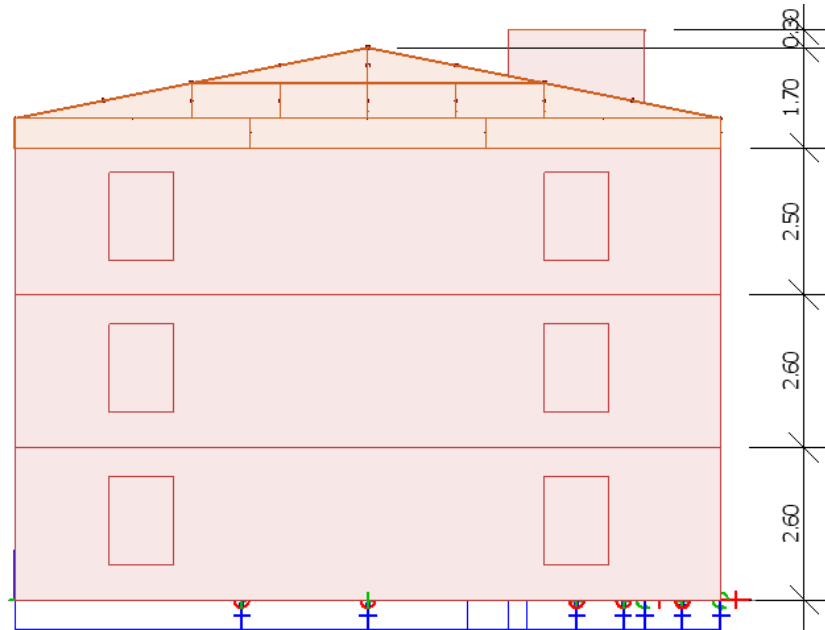

Fig.5. Facade towards X- (unit: m).

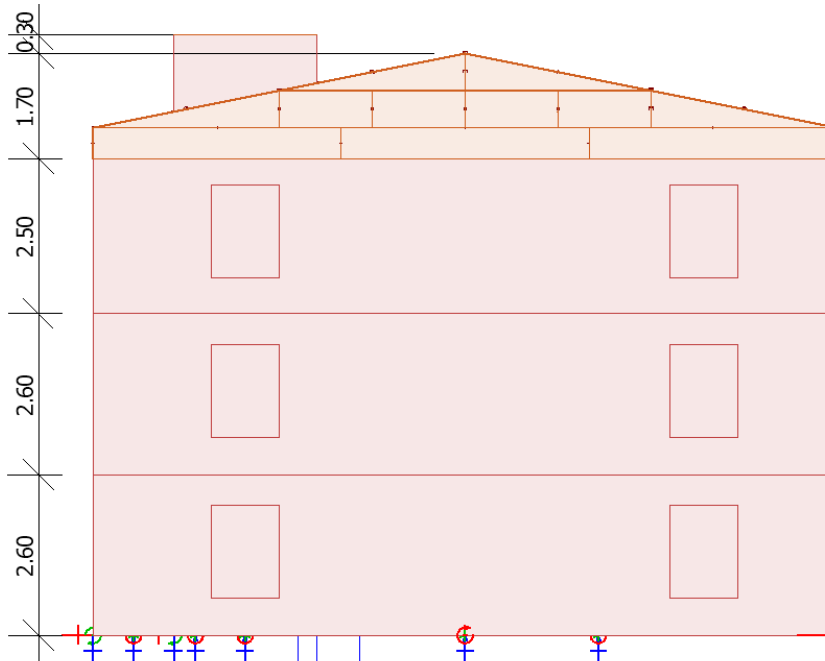

Fig.6. Facade towards X+ (unit: m).



Fig.7. Facade towards Y- (unit: m).

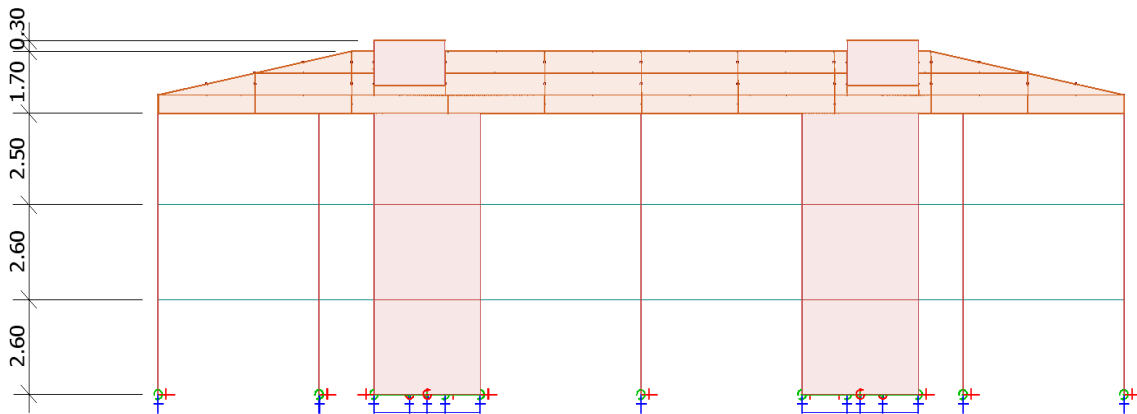

Fig.8. Facade towards Y+ (unit: m).

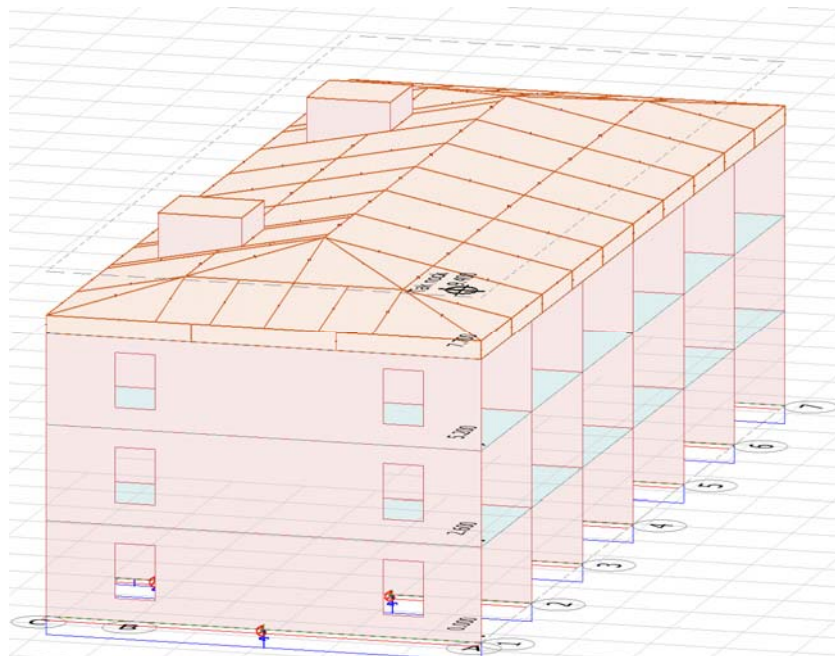

Fig.9. 3D view of modelled reference building.

After modelling the whole building, the next step was to define the necessary loads for the building. Permanent and temporary load cases were assumed in the load groups depending on the load types. The snow load on the roof was considered 2.5 kN/m^2 according to the Gävle's snow zone. Imposed and dead loads of the flooring were 2.5 kN/m^2 and 0.5 kN/m^2 , respectively which were applied on the floors as uniformly distributed loads. Moreover, a service load of 0.5 kN/m^2 was adopted for the roof. The structural dead load of the building was defined to be taken into account automatically by the program. The wind load was generated and applied by the program considering the wind speed of 23 m/s and terrain type II. Afterwards, various load combinations were generated by the program including the defined loads and load cases. The standard elements with $4/3/2$ nodes were selected. The completely modelled reference building was then analysed and designed.

3. Results and discussions

The obtained results from the analyses and designs of the reference and extended buildings are presented and discussed here.

3.1. Results from reference building

From the results, typical stress distributions in the slabs and walls of the reference building are illustrated in Figs. 10-11 and 12-13, respectively.

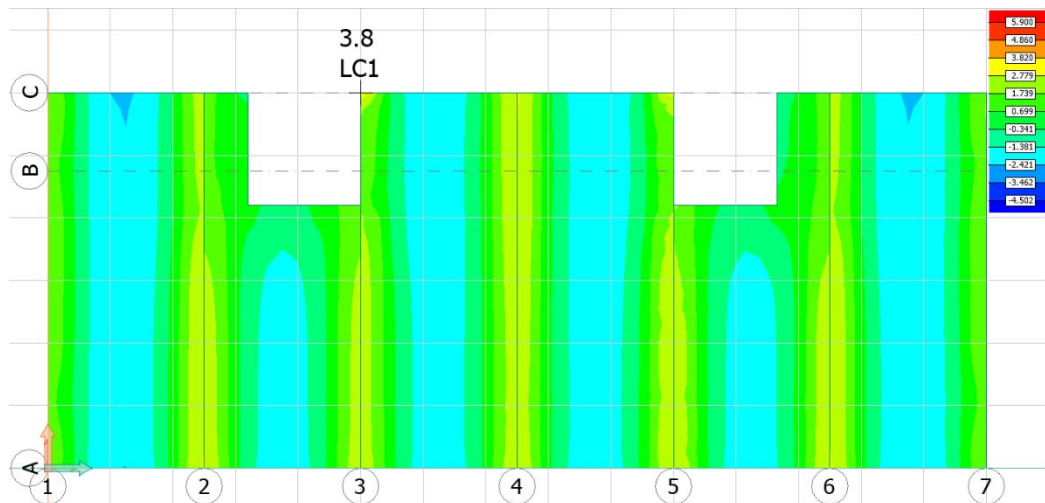

Fig.10. Stress distribution in slabs of storey I, Sigma X-top (unit: MPa).

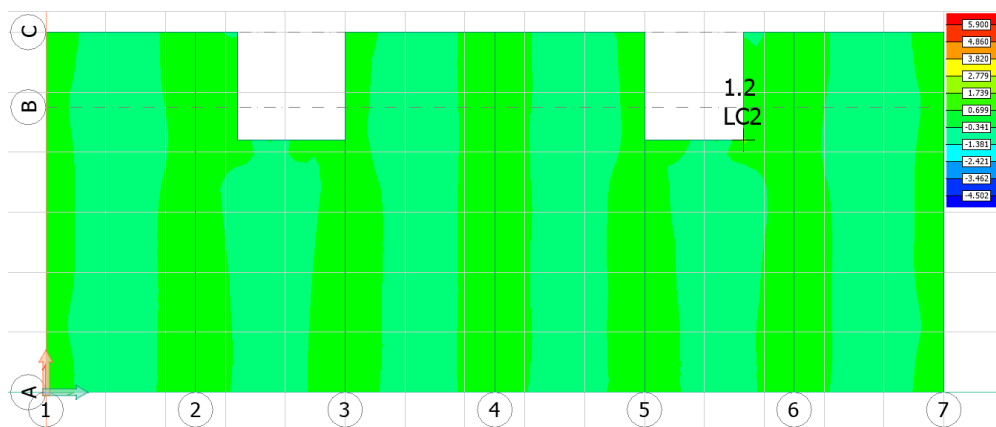

Fig.11. Stress distribution in slabs of storey I, Sigma Y-top (unit: MPa).

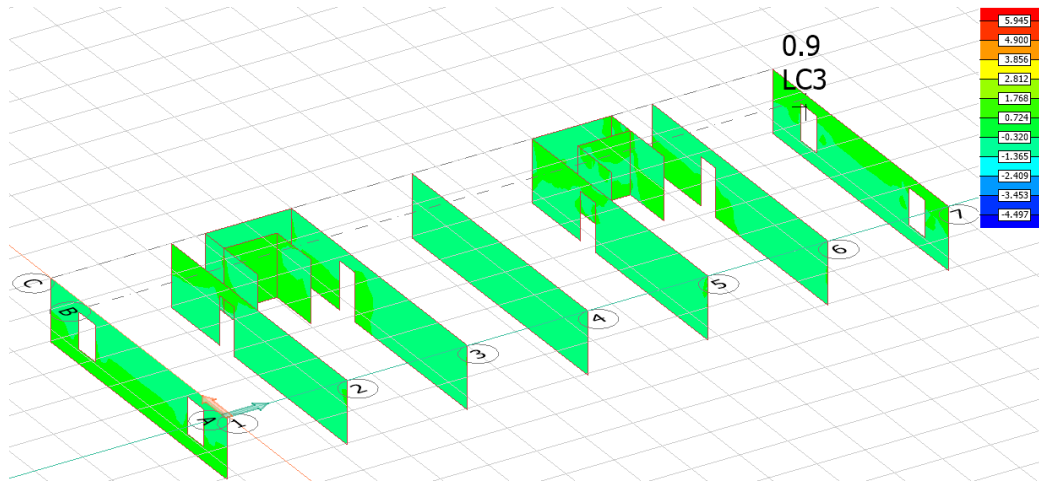

Fig.12. Stress distribution in walls of storey 2, Sigma X-top (unit: MPa).

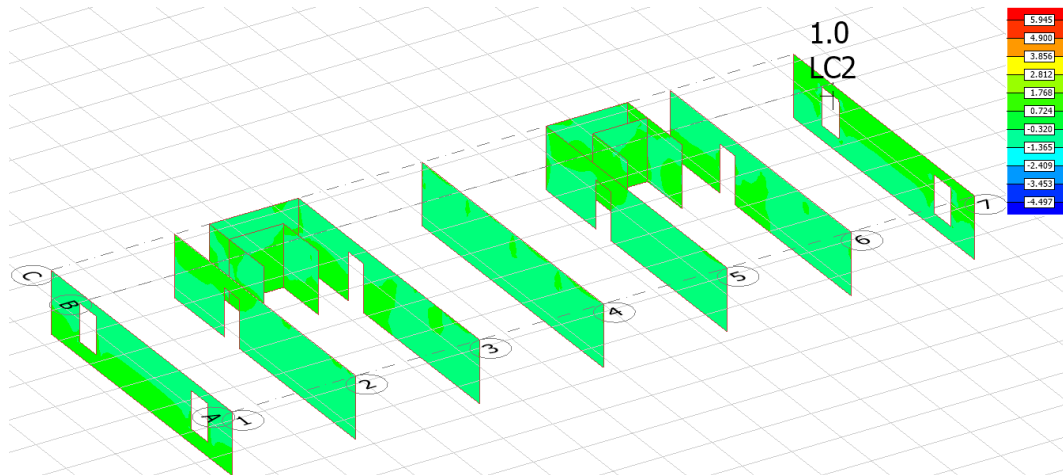

Fig.13. Stress distribution in walls of storey 3, Sigma X-top (unit: MPa).

The utilisation ratios of individual elements and the whole reference building can be seen in Fig.14. The goal for all the elements was to be designed and have utilisation ratios below 100% . It was resulted that the building could achieve acceptable utilisation ratios (Fig.14). Further, the building had a small and acceptable deflection. The stability analysis of the building was performed which led to the building being stable. In addition, the result of the analysis of the reference building demonstrated that the maximum vertical reaction force of the building was 231.6 kN .

3.2. Extended building

Since modelling, analysis and design of the reference building established acceptable results, the building was then vertically extended by one storey on its top as the fourth storey, while the roof lifted up from the third storey to cover the fourth one. The height of the fourth storey was 2.5 m like the third one. The plan and features of the fourth storey were as the same as the third one. This extended storey was modelled following

the same process mentioned in section 2.2. The 3D view of the modelled extended building is depicted in Fig.15.

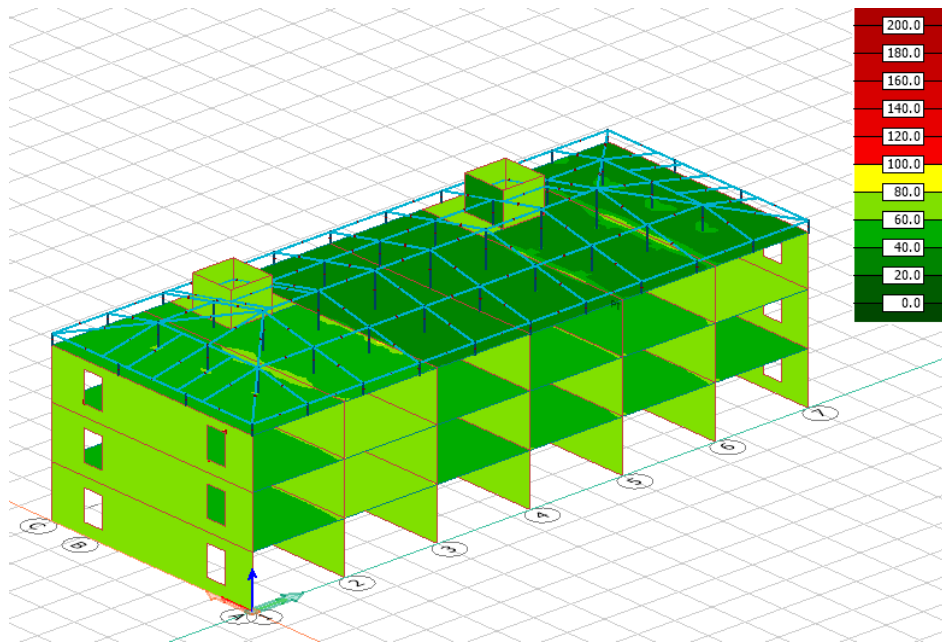

Fig.14. Utilisation ratios of reference building.

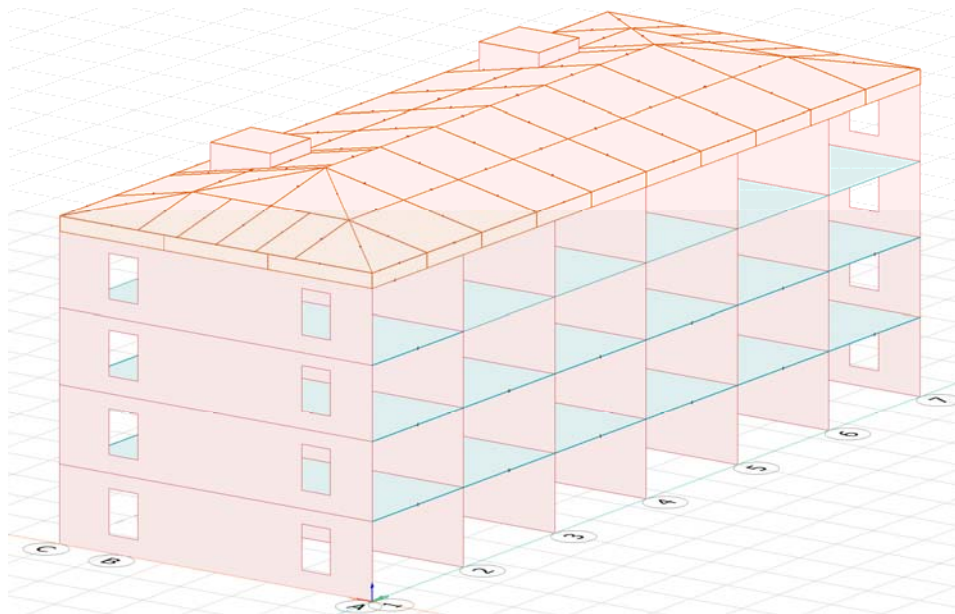

Fig.15. 3D view of modelled extended building.

The utilisation ratios of all the elements of the extended building were checked to see which elements had an excessive utilisation ratio higher than 100%. It was revealed that after the extension of the building

most of the load-bearing elements of storeys 1-3 had higher utilisation ratios than those of the reference building due to the vertical extension, but they were still below 100% and acceptable. Therefore, they did not need strengthening. However, there were seven elements including four load-bearing walls and three slabs that showed higher utilisation ratios than 100%, and accordingly took the risk of failure. Consequently, these seven elements needed strengthening to function well. Table 2 lists these elements along with their specifications and utilisation ratios. In the table, *W* and *P* designate walls and plates (slabs), respectively. The reinforcements were of the type K500C. Moreover, the listed elements in Table 2 are displayed in Figs.16-22.

Table 2. Elements of extended building having higher utilisation ratios than 100% before strengthening.

Element	Reinforcement (<i>mm</i>)	Utilisation Ratio (%)
<i>W.51.1</i>	<i>10@200</i>	<i>102</i>
<i>W.60.1</i>	<i>10@250</i>	<i>121</i>
<i>W.64.1</i>	<i>10@250</i>	<i>120</i>
<i>W.71.1</i>	<i>10@200</i>	<i>133</i>
<i>P.10.1</i>	<i>10@175</i>	<i>121</i>
<i>P.12.1</i>	<i>10@200</i>	<i>119</i>
<i>P.19.1</i>	<i>10@200</i>	<i>101</i>

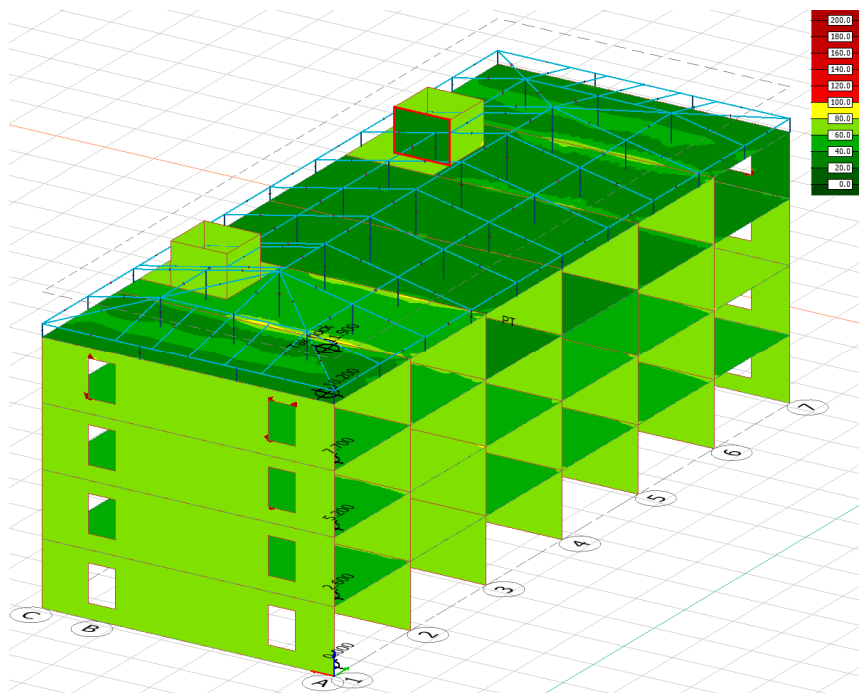

Fig.16. Wall (*W.51.1*).

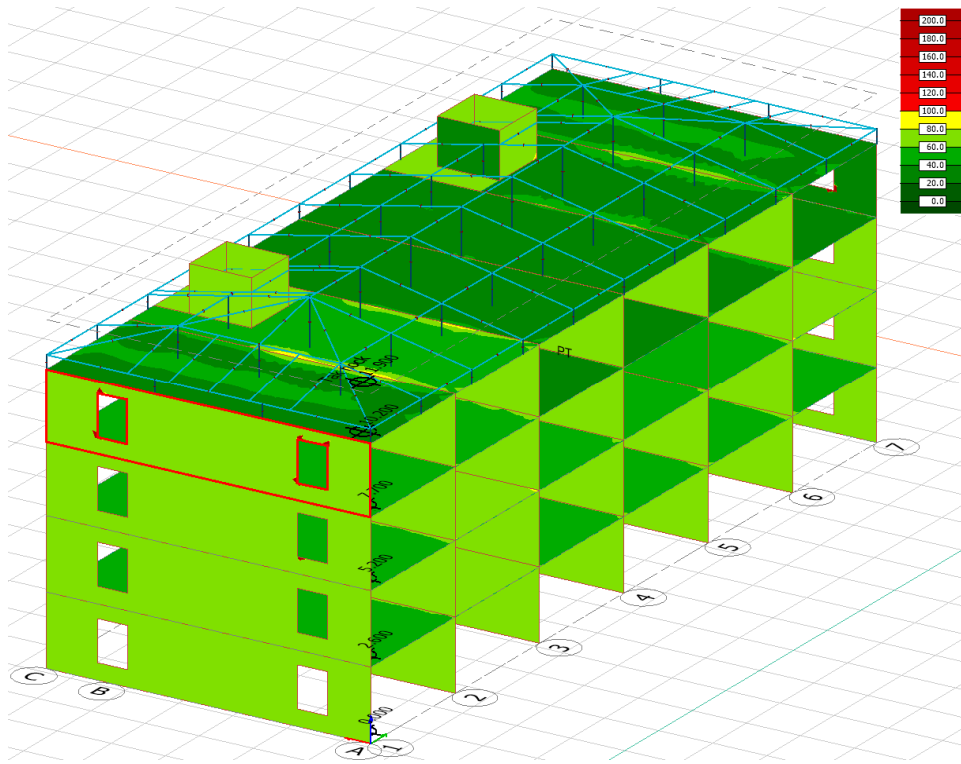

Fig.17. Wall (W.60.1).

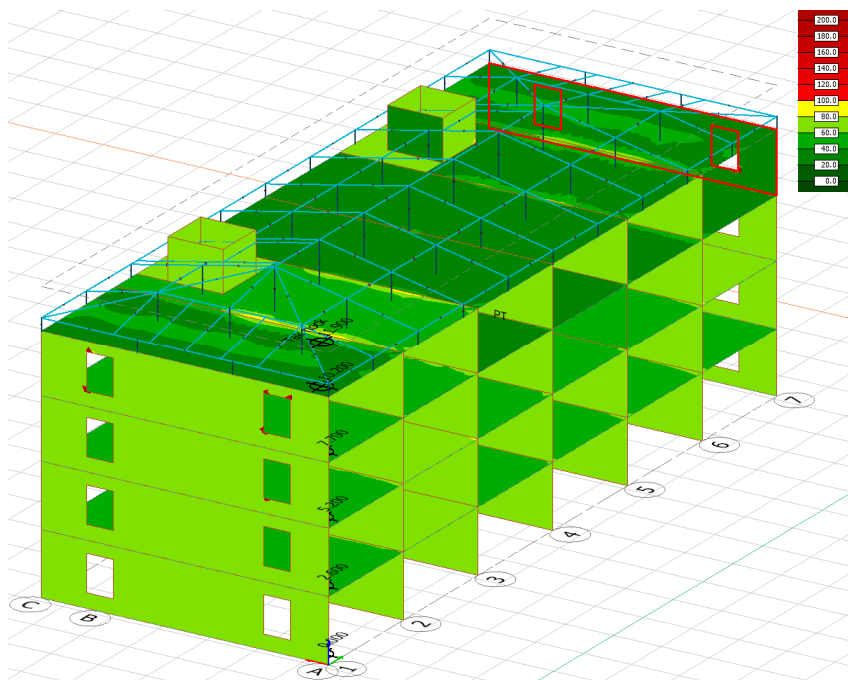

Fig.18. Wall (W.64.1).

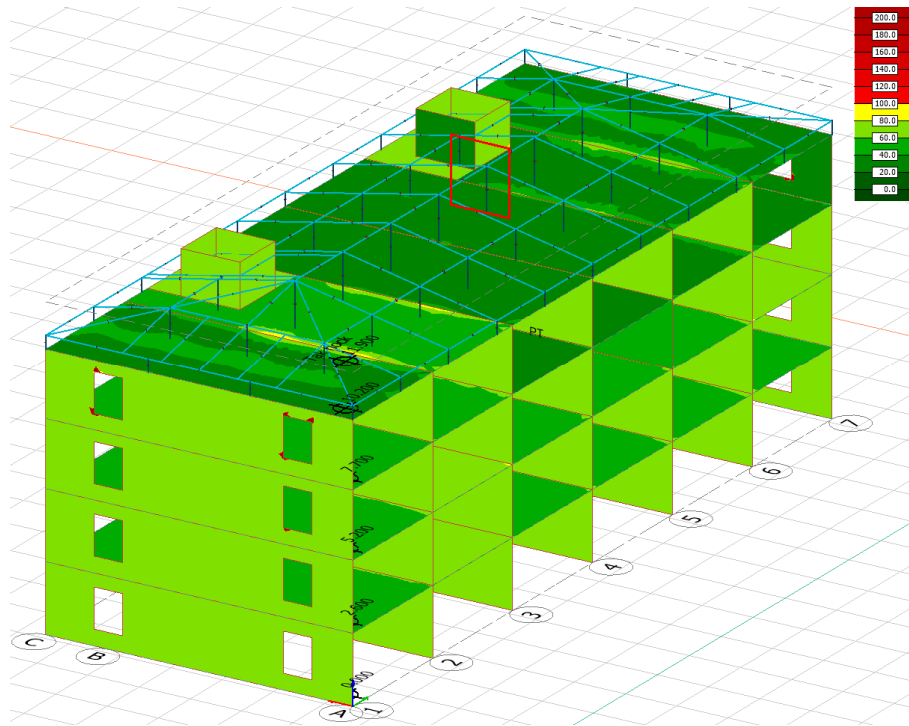

Fig.19. Wall (W.71.1).

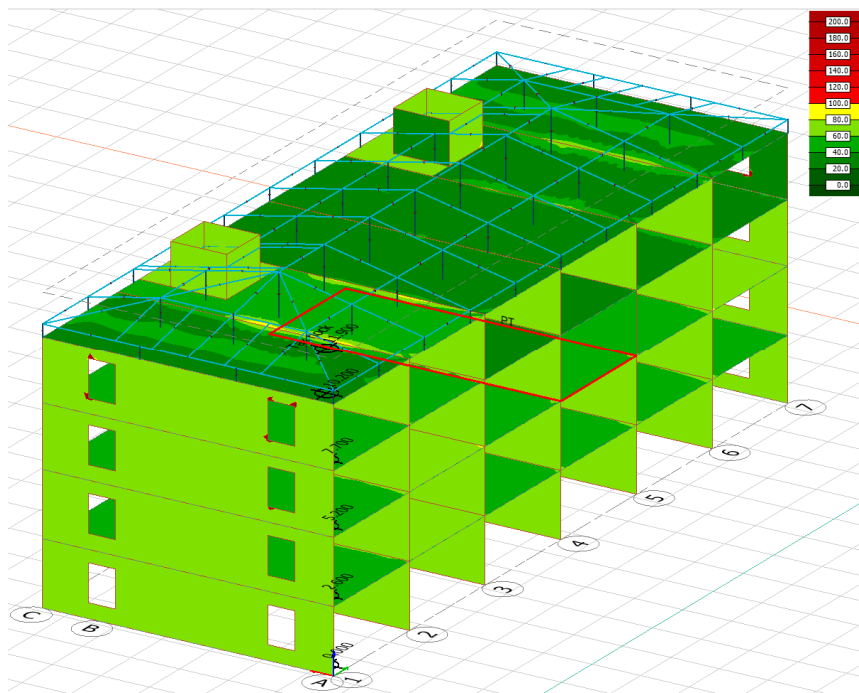

Fig.20. Slab (P.10.1).

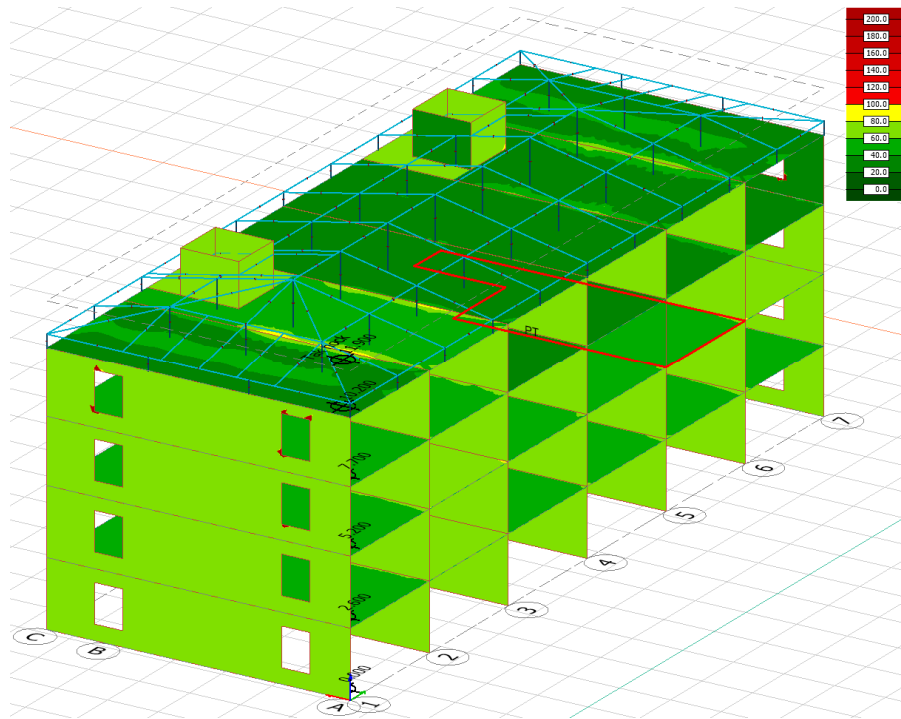

Fig.21. Slab (P.12.I).

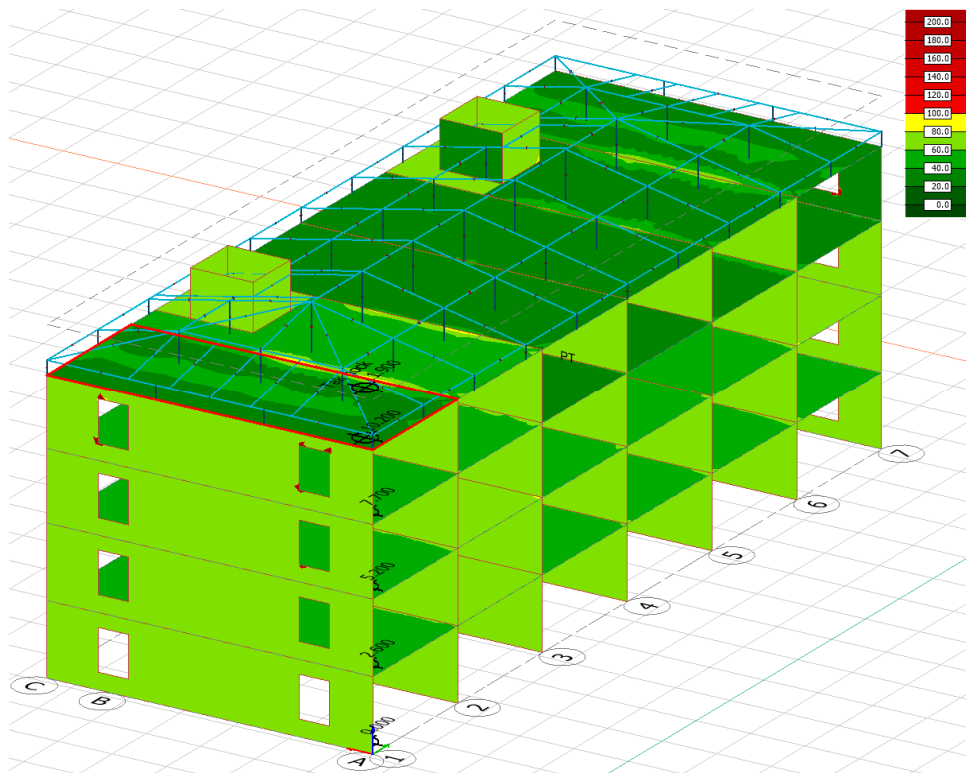

Fig.22. Slab (P.19.I).

In order to strengthen these seven elements, various strengthening solutions (SSs) were evaluated for the extended building to help them withstand the imposed loads owing to the extension. The reinforcement contents of *W.51.1*, *W.64.1*, *W.71.1* and *P19.1* were increased so that these elements could accomplish the utilisation ratios below 100% (Table 3). Steel columns with steel wind braces were considered to support *W.60.1* laterally and transfer the loads from the slabs and the loads above them to the foundation. These steel columns along with the steel beams supported the slabs on axis *A* between axes *1* and *2* including *P19.1*. The mentioned wind braces provided the frame stabilisation in the event of high wind. Steel beams were utilised at each end of *P.10.1* and continued to axis *3* to strengthen *P.10.1*. Furthermore, steel columns were employed at the intersection of *P12.1* and *P10.1* which helped both of them. These mentioned SSs are illustrated in Figs. 23-25. In storeys *1* and *2* of the building, steel columns were also added to the stairwell (Fig.26). The dimension of the steel beams and columns was IPE80 (S355). The steel material was chosen for the SSs since it has proven to be an easier and more appropriate strengthening method than RC from the practical perspective. On the other hand, applying the steel SSs does not interfere with the roles of the RC elements of the building. The achieved utilisation ratios and features of the elements of Table 2 after strengthening are summarised in Table 3. As it can be seen from the table, the utilisation ratios of all the elements led to ratios below 100% and acceptable.

Table 3. Elements of extended building obtaining lower utilisation ratios than 100% after strengthening.

Element	Reinforcement (mm)	Utilisation Ratio (%)
<i>W.51.1</i>	10@150	79
<i>W.60.1</i>	10@250	99
<i>W.64.1</i>	10@150	72
<i>W.71.1</i>	12@150	70
<i>P.10.1</i>	10@175	91
<i>P.12.1</i>	10@200	81
<i>P.19.1</i>	10@150	77

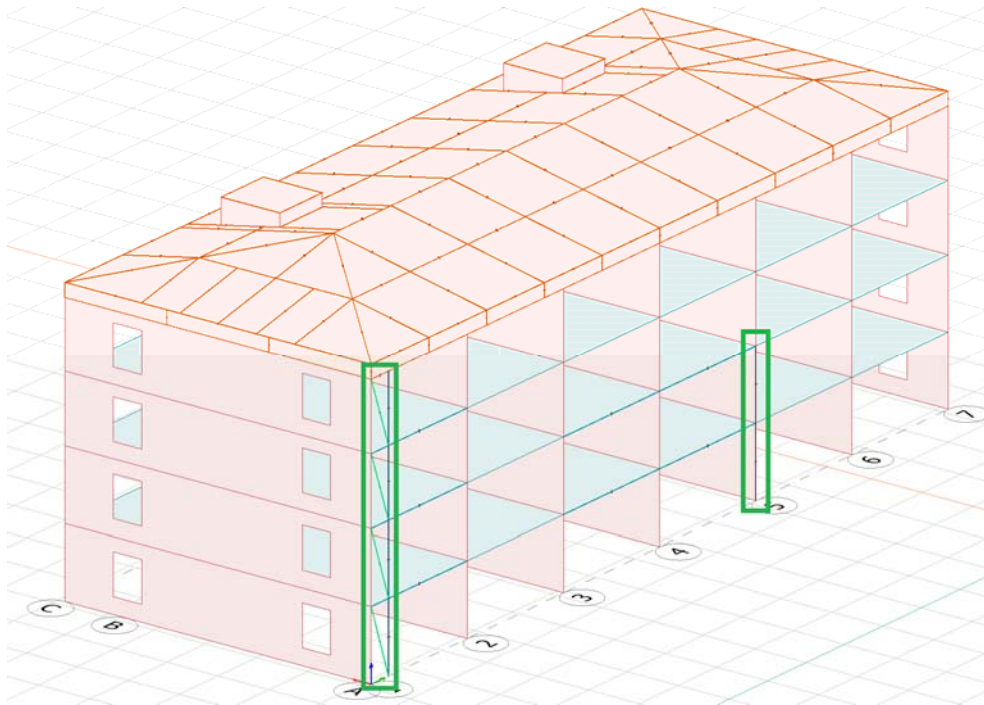

Fig.23. Strengthening wall and slabs with steel columns and wind braces.

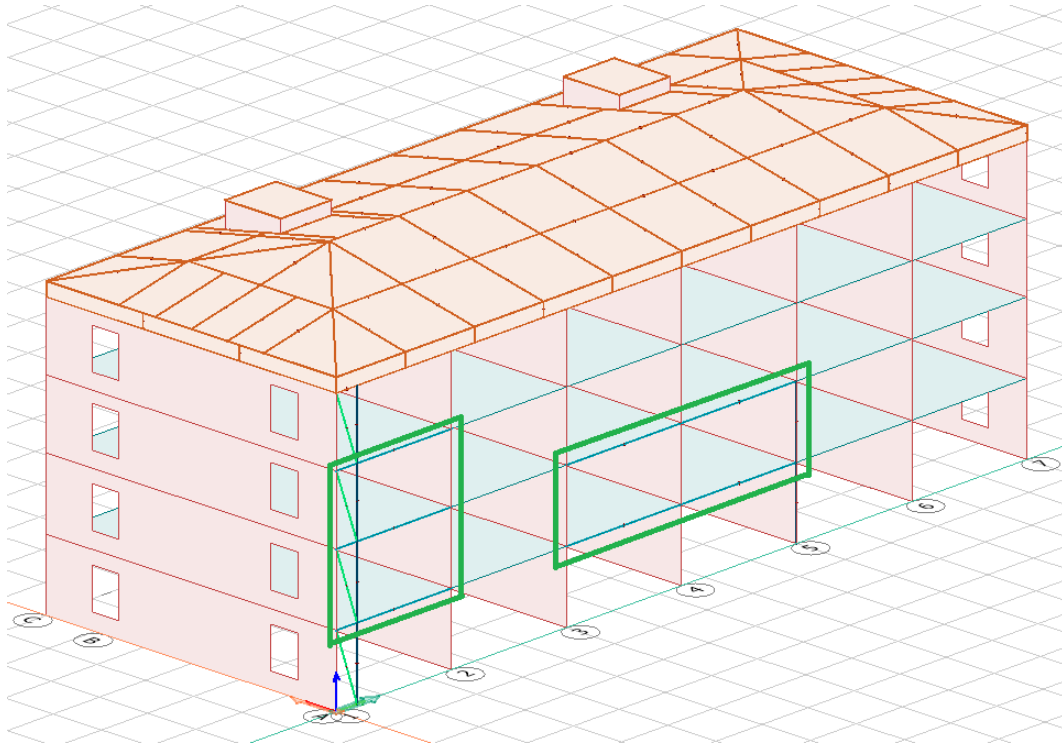

Fig.24. Strengthening wall and slabs with steel beams.

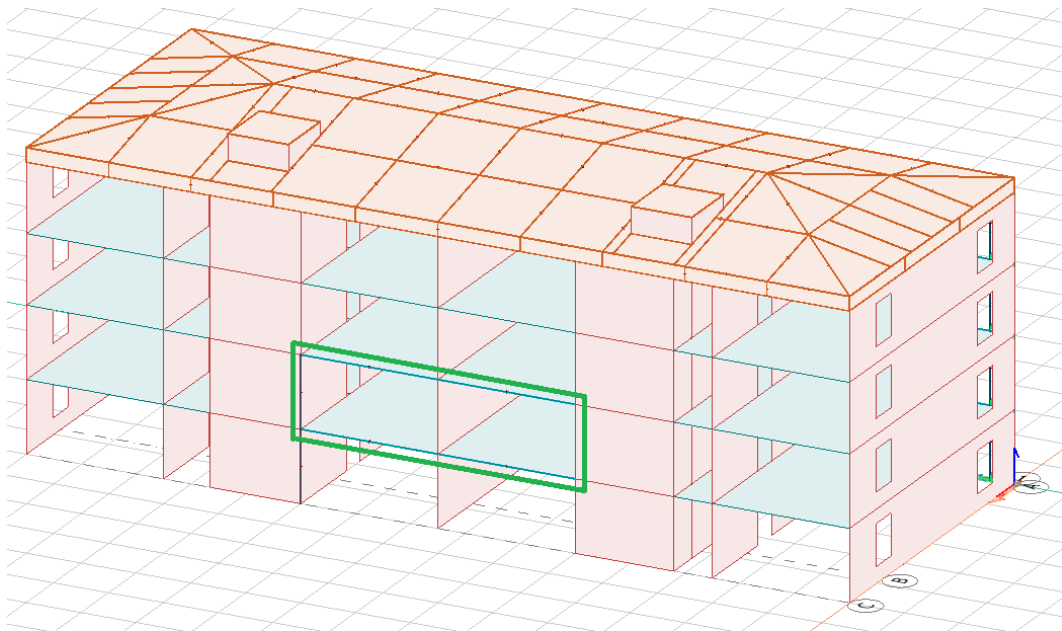

Fig.25. Strengthening slabs with steel beams.

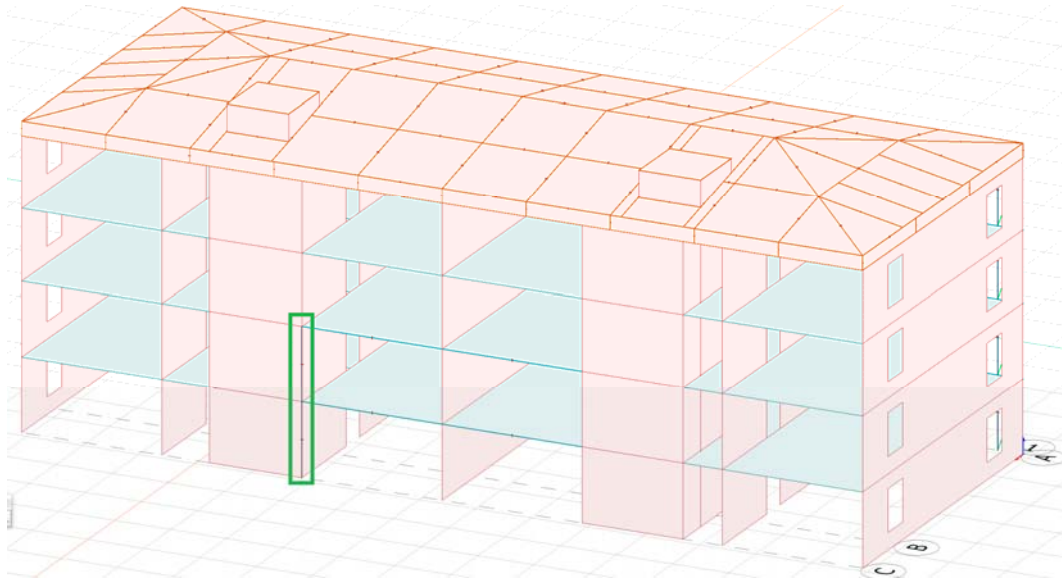

Fig.26. Strengthening stairwell with steel columns.

The results obtained from the analysis revealed that the deflection of the extended building was increased a little compared with the reference building and it was acceptable. The stability analysis of the extended building was conducted to check if the building was stable after the extension. The result indicated that the building was stable and it could successfully carry the added loads. Typical distributions of stresses in the slabs and walls of the extended building are depicted in Figs. 27-28 and 29-30, respectively. The maximum vertical reaction force of the extended building was 335.5 kN.

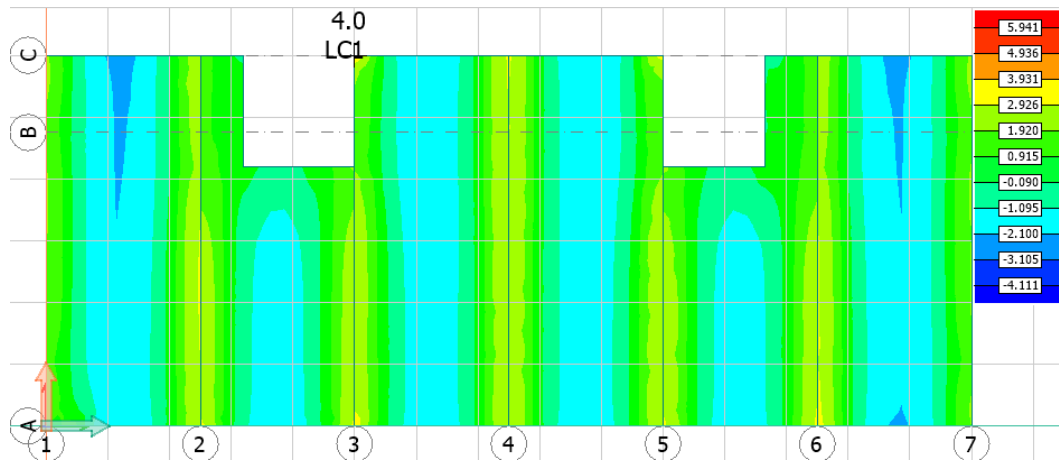

Fig.27. Stress distribution in slabs of storey 1, Sigma X-top (unit: MPa).

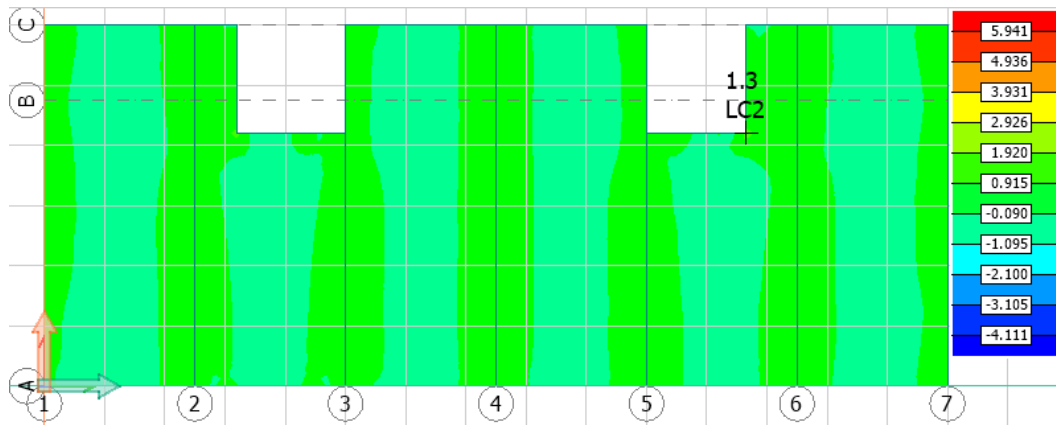

Fig.28. Stress distribution in slabs of storey 1, Sigma Y-top (unit: MPa).

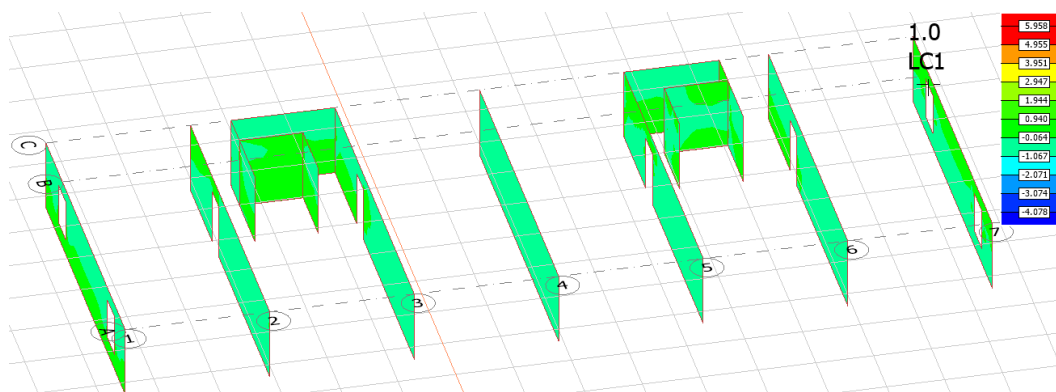

Fig.29. Stress distribution in walls of storey 2, Sigma X-top (unit: MPa).

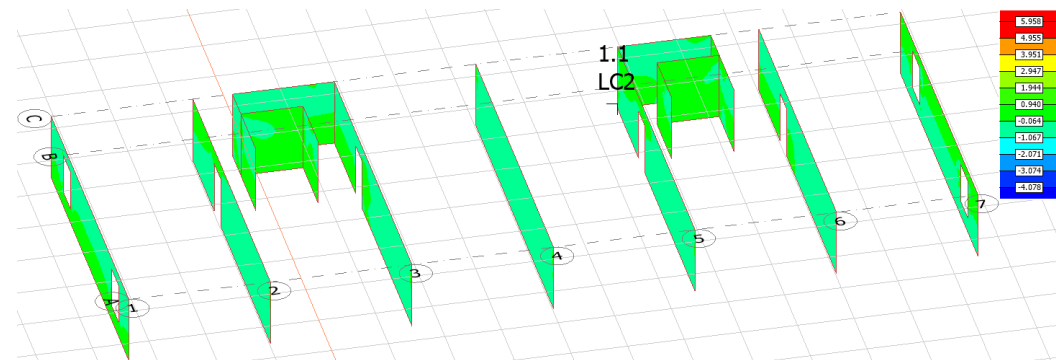

Fig.30. Stress distribution in walls of storey 3, Sigma X-top (unit: MPa).

3.3. Comparisons of results from reference and extended buildings in terms of stresses, utilisation ratios, reaction forces and deflections

By the vertical extension of the building, the stresses of the lower load-bearing elements of the building, storeys 1-3, were increased. These issues could be observed from comparisons of Figs. 10-13 with their corresponding Figs. 27-30.

The utilisation ratio of a structural element is the ratio between applied external loads and load-bearing capacity of the element, which is taken into account in design. The load-bearing capacity must be greater than the total external load in order for the element to be considered safe and not fail. With increasing the load on the reference building through the vertical extension, it was resulted that the utilisation ratios of most load-bearing elements of the building became higher. Owing to the extension, the utilisation ratios of the elements of the reference building that were higher than 85% were expected to increase with a high probability of exceeding the limit value 100%, because additional loads were imposed to the lower parts of the building. Fig.31 elaborates those slabs which got higher utilisation ratios than 100% due to the extension. As it can be seen from the figure, the utilisation ratios of the slabs were decreased using the SSs. The same process can be observed in Fig.32 for the load-bearing walls before and after applying the SSs. These figures clearly state the applicability of the proposed SSs which gave acceptable results from the utilisation ratio perspective.

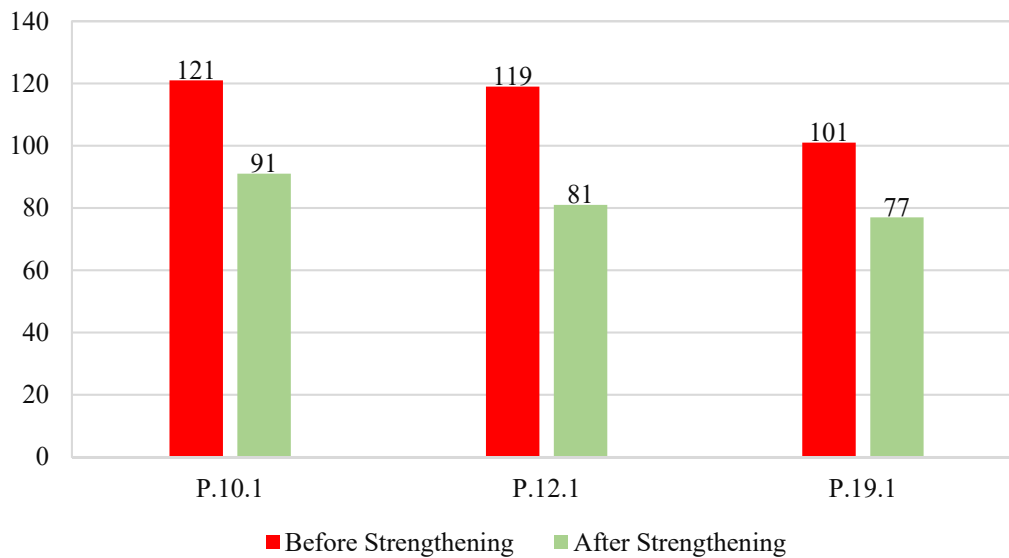

Fig.31. Comparison of utilisation ratios (%) of slabs of extended building before and after strengthening.

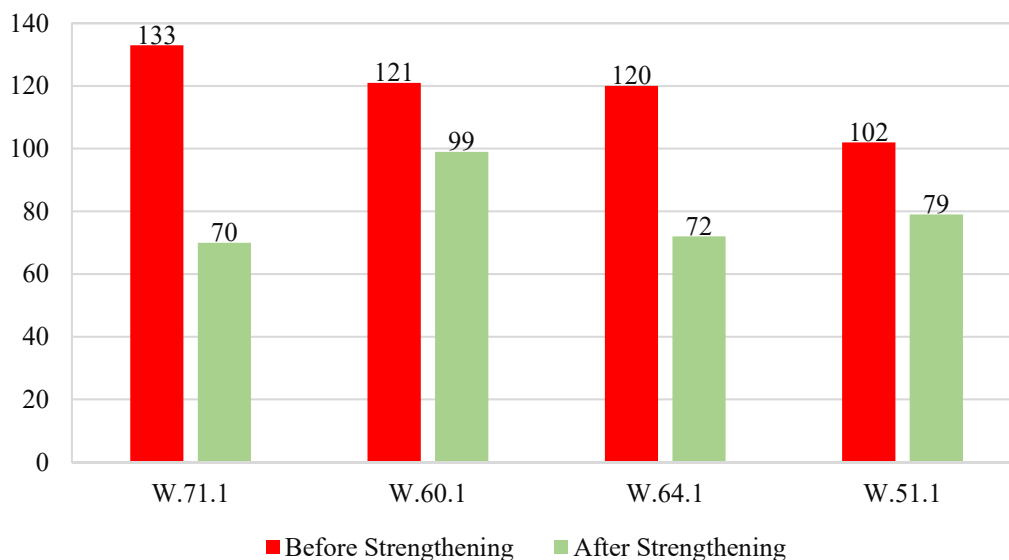

Fig.32. Comparison of utilisation ratios (%) of load-bearing walls of extended building before and after strengthening.

The vertical reaction forces of the walls that came down to the ground were increased with increasing the imposed loads, and there was a clear difference between them in the reference and extended buildings. The maximum vertical reaction force for the reference building was 231.6 kN which was increased to 335.5 kN .

The deflections of the reference and extended buildings were accounted for the serviceability limit state. It was concluded that the deflections were small and acceptable, and also had a small difference. It was important to check the deflections since large deflections could create a feeling of insecurity in residents and negatively affect non-load-bearing walls. This issue was avoided by having small deflections. These small deflections could be because of the fact that the load-bearing elements of the building were made of concrete, which was a more stable and stiffer material compared with, for example, wood. Moreover, only one storey was added to the building and the bending stiffness of concrete was high, so that loads from the new storey could successfully be transferred to the load-bearing walls, which could then carry the loads down to the foundation and further down to the ground.

4. Conclusions

The purpose of this study was to examine whether a reference RC building in Gävle in Sweden could successfully withstand the vertical extension by one storey. The FEM program as an advanced calculation program which considers all the requirements for modelling, analysis and design of the building was used in this research. The reference and extended buildings were completely modelled, analysed and designed. The buildings were designed in the serviceability and ultimate limit states. The stresses, utilisation ratios, reaction forces and deflections were achieved as the results. It was generally concluded that stresses of the load-bearing elements of storeys 1-3 of the extended building were increased due to the extension. Also, most of the load-bearing elements of the extended building had higher utilisation ratios compared with those of the reference building. However, only seven elements of the extended building could experience higher utilisation ratios than 100% including three slabs and four load-bearing walls. Different SSs were proposed for these elements. Some of these elements could obtain the acceptable utilisation ratios below 100% by enhancing their reinforcement contents. Steel beams, columns and braces were used for other elements in order to strengthen them. These strengthened elements led to acceptable utilisation ratios below 100% as well. As it was expected, the vertical reaction forces of the extended building were increased compared with the reference building. Deflections of the building before and after the extension were small, acceptable and close to one another. The stability of the reference and extended buildings was checked which revealed that the buildings were stable. As a consequence, it was found that the reference building could handle the vertical extension adopting the applied SSs. This study can be of interest and useful for practical designers and engineers who wish to assess the possibility of the vertical extension of RC buildings.

Nomenclature

- EKS – Swedish national annex
- FEM – StruSoft FEM-Design
- RC – reinforced concrete
- SSs – strengthening solutions
- 3D – three-dimensional

References

- [1] Statistikmyndigheten (2021): *Befolkningsprognos för Sverige*.– <https://www.scb.se/hitta-statistik/sverige-i-siffror/manniskorna-i-sverige/befolkningsprognos-for-sverige/>.

- [2] Sundling R., Blomsterberg Å. and Landin A. (2019): *Enabling energy-efficient renovation: the case of vertical extension to buildings.*– Construction Innovation, vol.19, No.1, pp.2-14.
- [3] Pomeroy J. (2012): *Room at the top-the roof as an alternative habitable / social space in the Singapore context.*– Journal of Urban Design, vol.17, No.3, pp.413-424.
- [4] Blaschko M. and Zilch K. (1999): *Rehabilitation of concrete structures with CFRP strips glued into slits.*– Technical University of Munich, Munich, Germany.
- [5] Koumousis V. (2002): *Reinforced concrete frame building with an independent vertical extension.*– World Housing Encyclopedia, Report 17, p.14.
- [6] Bergsten S. (2005): *Industrialised Building Systems: Vertical Extension of Existing Buildings by Use of Light Gauge Steel Framing Systems and 4D CAD Tools.*– Licentiate thesis, Luleå University of Technology, p.102.
- [7] Kyakula M., Kapasa S. and Opus E.A. (2006): *Considerations in vertical extension of reinforced concrete structures.*– Proceedings from the International Conference on Advances in Engineering and Technology, pp.109-116.
- [8] Kim J-P., Kim S-S., Choi K-H. and Jeon B-G. (2006): *Study on the extension of reinforced concrete slabs.*– Journal of the Korea Concrete Institute, vol.18, No.3, pp.321-330.
- [9] De Lorenzis L. and Teng J.G. (2007): *Near-surface mounted FRP reinforcement: An emerging technique for strengthening structures.*– Composites Part B: Engineering, vol.38, No.2, pp.119-143.
- [10] Johansson B. and Thyman M. (2013): *Strengthening of buildings for storey extension.*– Chalmers University of Technology.
- [11] Al-Nu'man B.S. (2016): *Assessment of strengthening scheme of existing buildings extended by adding additional floors.*– Eurasian Journal of Science and Engineering, vol.2, No.1, pp.28-40.
- [12] Shin J., Scott D.W., Stewart L.K., Yang C-S., Wright T.R. and DesRoches R. (2016): *Dynamic response of a full-scale reinforced concrete building frame retrofitted with FRP column jackets.*– Engineering Structures, vol.125, pp.244-253.
- [13] Sundling R. (2019): *A development process for extending buildings vertically - based on a case study of four extended buildings.*– Construction Innovation, vol.19, No.3, pp.367-385.
- [14] EN 1990 (2002): *Eurocode-Basis of structural design.*– European Committee for Standardization: Brussels, Belgium, 2010.
- [15] EN 1991-1-1 (2002): *Eurocode 1: Actions on structures-Part 1-1: General actions — Densities, self-weight, imposed loads for buildings.*– European Committee for Standardization: Brussels, Belgium, 2011.
- [16] EN 1992-1-1 (2005): *Eurocode 2: Design of concrete structures-Part 1-1: General rules and rules for buildings.*– European Committee for Standardization: Brussels, Belgium, 2008.
- [17] EN 1993-1-1 (2005): *Eurocode 3: Design of steel structures-Part 1-1: General rules and rules for buildings.*– European Committee for Standardization: Brussels, Belgium, 2008.
- [18] EN 1995-1-1 (2004): *Eurocode 5: Design of timber structures-Part 1-1: General — Common rules and rules for buildings.*– European Committee for Standardization: Brussels, Belgium, 2009.
- [19] EKS 10: BFS 2015:6 (2015): *Swedish national annex for application of Eurocodes.*– The National Board of Housing, Building and Planning: Karlskrona, Sweden.

Received: September 8, 2021

Revised: January 15, 2022